

Mounting Surface : ISO 4401-AC-05-4-A, CETOP-5, NFPA-DO2

Up to 25 MPa (3630 PSI), 70 L/min (18.5 U.S.GPM)

The modular valves are functional elements with which a hydraulic system can be composed and built easily by stacking them with the mounting bolts. Therefore, no piping is required for the manufacture of the hydraulic systems. Yuken's 03 Series Modular Valves are widely used to compose the hydraulic systems for the various industrial and marine equipment including machine tools, special purpose machines, steel mill equipment and ships. The valves have standardized mounting surface conforming to ISO 4401-AC-05-4-A and optimum thickness for the stacking.



■ Example of Stacking Configuration

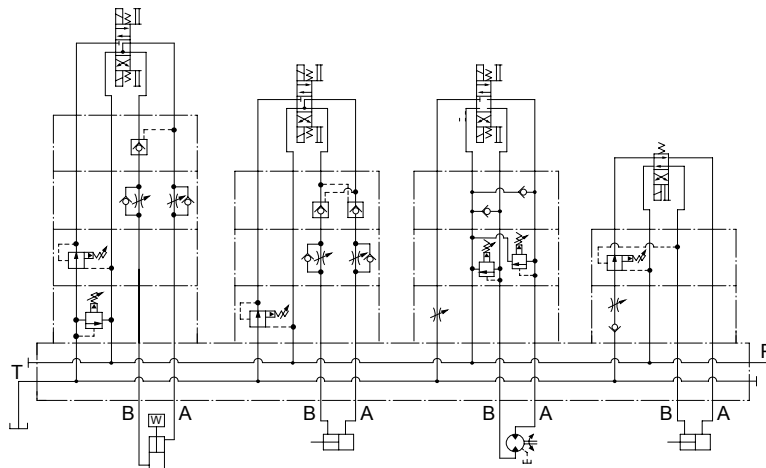

3/8, Solenoid Operated Directional Valve (DSG-03)

Modular Valves











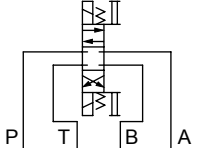

Base Plate (MMC-03)

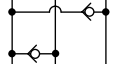

■ Type of Modular Valve

Class	Model Numbers	Graphic Symbols	Page	Class	Model Numbers	Graphic Symbols				Page
						P	T	B	A	
	Solenoid Operated Directional Valve (S-)DSG-03-***-50/5090 T-DSG-03-***-50 G-DSG-03-***-50/5090		★		Flow Control Valves (for "P-Line") MFP-03-11/1190					20
Pressure Control Valves	Relief Valves (for "P-Line") MBP-03-**-30/3090		7	Flow Control Valves	Flow Control and Check Valves (for "A-Line", Metre-out) MFA-03-X-11/1190					20
	Relief Valves (for "A-Line") MBA-03-**-30/3090		7		Flow Control and Check Valves (for "A-Line", Metre-in) MFA-03-Y-11/1190					20
	Relief Valves (for "B-Line") MBB-03-**-30/3090		7		Flow Control and Check Valves (for "B-Line", Metre-out) MFB-03-X-11/1190					20
	Relief Valves (for "A&B-Lines") MBW-03-**-30/3090		7		Flow Control and Check Valves (for "B-Line", Metre-in) MFB-03-Y-11/1190					20
	Reducing Valves (for "P-Line") MRP-03-**-30/3090		10		Flow Control and Check Valves (for "A&B-Lines", Metre-in) MFW-03-X-11/1190					20
	Reducing Valves (for "A-Line") MRA-03-**-30/3090		10		Temperature Compensated Throttle and Check Valves (for "A-Line", Metre-out) MSTA-03-X-20/2090					24
	Reducing Valves (for "B-Line") MRB-03-**-30/3090		10		Temperature Compensated Throttle and Check Valves (for "B-Line", Metre-out) MSTB-03-X-20/2090					24
	Reducing Valves for Low Pressure Setting (for "P-Line") MRLP-03-10/1080/1090		13		Temperature Compensated Throttle and Check Valves (for "A&B-Lines", Metre-out) MSTW-03-X-20/2090					24
	Reducing Valves for Low Pressure Setting (for "A-Line") MRLA-03-10/1080/1090		13		Throttle Valves (for "P-Line") MSP-03-30/3090					27
	Reducing Valves for Low Pressure Setting (for "B-Line") MRLB-03-10/1080/1090		13		Check and Throttle Valves (for "P-Line") MSCP-03-20/2090					29
	Sequence Valves (for "P-Line") MHP-03-**-20/2090		17		Throttle and Check Valves (for "A-Line", Metre-out) MSA-03-X-40/4090					31
	Counterbalance Valves (for "A-Line") MHA-03-**-20/2090		17		Throttle and Check Valves (for "A-Line", Metre-in) MSA-03-Y-40/4090					31
	Counterbalance Valves (for "B-Line") MHB-03-**-20/2090		17		Throttle and Check Valves (for "B-Line", Metre-out) MSB-03-X-40/4090					31
	★ For the details of solenoid operated directional valves, see the following catalogues: (S-)DSG-03-***-50/5090 } Pub.EC-0403 T-DSG-03-***-50 } G-DSG-03-***-50/5090 : Pub.EC-0405					Throttle and Check Valves (for "B-Line", Metre-in) MSB-03-Y-40/4090				31
					Throttle and Check Valves (for "A&B-Lines", Metre-out) MSW-03-X-40/4090				31	
					Throttle and Check Valves (for "A&B-Lines", Metre-in) MSW-03-Y-40/4090				31	

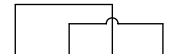
■ Type of Modular Valve

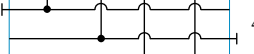
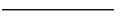
Class	Model Numbers	Graphic Symbols	Page
	Solenoid Operated Directional Valve (S-)DSG-03-***-50/5090 T-DSG-03-***-50 G-DSG-03-***-50/5090		★
Directional Control Valves	Check Valves (for "P-Line") MCP-03-**-10/1090		34
	Check Valves (for "A-Line") MCA-03-**-20/2090		34
	Check Valves (for "B-Line") MCB-03-**-20/2090		34
	Check Valves (for "T-Line") MCT-03-**-10/1090		34
	Check Valves (for "P&T-Lines") MCPT-03-P*-T*-10/1090		36
	Anti-Cavitation Valves MAC-03-10/1090		38
	Pilot Operated Check Valves (for "A-Line") MPA-03-**-20/2090		39
	Pilot Operated Check Valves (for "B-Line") MPB-03-**-20/2090		39
Pilot Operated Check Valves (for "A&B-Lines") MPW-03-**-20/2090		39	
Modular Plates and Mounting Bolts	End Plates (Blocking plates) MDC-03-A-10/1090		42
	End Plates (Bypass plates) MDC-03-B-10/1090		42
	Connecting Plates MDS-03-10/1090		43
	Base Plates MMC-03-T-**-21/2180/2190		44
	Bolt Kits MBK-03-**-10/1090		47

★ For the details of solenoid operated directional valves, see the following catalogues:

(S-)DSG-03-***-50/5090 } Pub.EC-0403
 T-DSG-03-***-50 }
 G-DSG-03-***-50/5090 : Pub.EC-0405



■ Instructions

● Caution in the selection of valves and circuit designing

The selection of modular valves, to suit a particular function or hydraulic circuit, are made in exactly the same way as conventional valves, taking into account of the flow and pressure of each valve to be used. In some cases, the stacking system may be restricted, so please refer to the following instructions for stacking sequence. Please note, that when designing a system using modular stacking valves, due consideration should be given to working space for future maintenance.

● Stacking sequence when using reducing valves (for "A" or "B" line) and pilot operated check valves.

Because reducing valves are spool type, there is an internal leakage. In the stacking sequence shown in the drawing left (incorrect), the cylinder moves due to leakage through the pilot pressure line.

Consequently, retaining the position of the cylinder using a pilot operated check valve becomes impossible. The stacking sequence shown in the drawing right (correct) is required in order to retain the cylinder position.

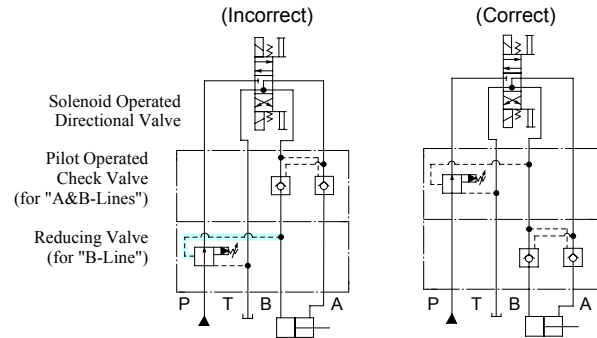

● Stacking sequence when using reducing valves (for "A" or "B" line) and throttle and check valves (for metre-out).

In B to T flow in the drawing left (incorrect), pressure is generated at the throttle part with a throttle effect of the throttle and check valve. Depending upon the pressure so generated, the reducing valve may perform a pressure reducing function which causes a shortage of output power of the cylinder and spoils the smooth operation of the cylinder. Therefore, stacking sequence in the drawing right (correct) is required in this combination.

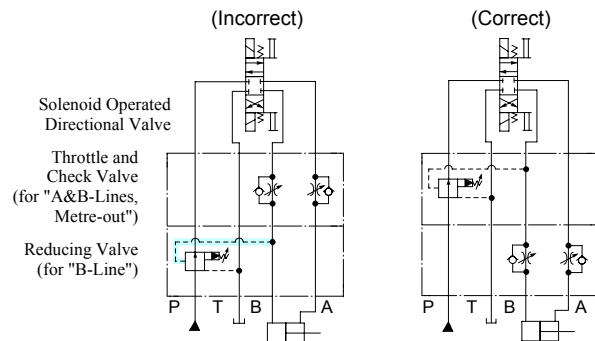

● Stacking sequence when using pilot operated check valves and throttle and check valves (metre-out).

In A to T flow in the drawing left (incorrect), pressure is generated at the throttle part with a throttle effect of the throttle and check valve.

The pressure so generated acts to shut the pilot operated check valve and eventually creates an open and shut operation of the valve repeatedly which may cause the cylinder to have a knocking effect (the same effect will occur in the case of B to T flow). Therefore, the stacking sequence in the drawing right (correct) is required in this combination.

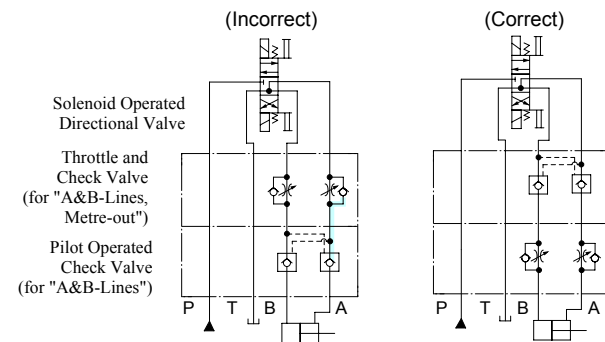

Specifications

Max. Operating Pressure 25 MPa (3630 PSI) ★¹
 Max. Flow 70 L/min (18.5 U.S. GPM) ★²
 Number of Stack 1 to 5 stacks ★³

- ★ 1. 31.5 MPa (4570 PSI) for relief moduler valve (MBP/MBA/MBB/MBW)
- ★ 2. 120 L/min (31.7 U.S.GPM) for throttle and check moduler valve (MSA/MSB/MSW)
- ★ 3. Solenoid operated directional valve is included in the number of stack.

3/8 Solenoid Operated Directional Valves

YUKEN 03 SERIES MODULAR VALVES are designed for use with solenoid operated directional valve having an ISO 4401-AC-05-4-A (CETOP-5, NFPA-D02) interface such as Yuken's DSG-03. Please refer to the Catalogue No. Pub. EC-0403 for details.

Hydraulic Fluids

Fluid Types

Any type of hydraulic fluid listed in the table below can be used.

Petroleum base oils	Use fluids equivalent to ISO VG 32 or VG 46.
Synthetic fluids	Use phosphate ester or polyol ester fluid. When phosphate ester fluid is used, prefix "F-" to the model number because the special seals (fluororubber) are required to be used.
Water containing fluids	Use water-glycol fluid.

Note: For use with hydraulic fluids other than those listed above, please consult your Yuken representatives in advance.

Recommended Viscosity and Temperatures

Always be sure to use hydraulic fluids within the stipulated conditions shown below:
 Viscosity: 15 to 400 mm²/s (77 to 1800 SSU), Temperature: -15 to +70°C (5 to 160°F)

Control of Contamination

Due caution must be paid to maintaining control over contamination of the hydraulic fluids which may otherwise lead to breakdowns and shorten the life of the valve. Please maintain the degree of contamination within NAS 1638-Grade 12. Use 25 μm or finer line filter.

Base Plates and Sub-Plates

When mounting the modular valves, use base plates and sub-plates specified below. If these base plates and the sub-plates are not used, ensure that the mounting surface has a good machined finish.

Base Plates		Sub-Plates	
Model Numbers	Page	Model Numbers	Page
MMC-03-T-* -21/2180/2190	44	DSGM-03* -40/2180/2190	★

★ For the details of Sub-Plate, see the following DSG-03 solenoid operated directional valve catalogues: Catalogue No. Pub. EC-0403.

Mounting Bolts

03 Series modular valves are mounted using stud bolts which are supplied in a kit form. When mounting, see the following table for tightening torque. After the test run, be sure to tighten again firmly within the specified torque.

Bolt Kit Model Numbers	Tightening torque Nm (in. lbs.)
MBK-03-* -10 MBK-03-* -1090	12-15 (106-133)



■ Assembly

Assembly should be carried out in clean conditions and in accordance with the following procedure. Cautious attention should be paid to ensure that the interface of the valves are clean and free from dirt or other foreign materials.

● Assembly Procedure:

- 1) Screw-in the four stud bolts, fully into the tapped holes on the mounting surface of the specified base plate, sub-plate or manifold.
- 2) Stack the modular valves and solenoid operated directional valves in accordance with the hydraulic circuit, place the O-ring inserted surface face onto the base plate and make sure that the port arrangement of the modular valves are in the correct position before stacking the valves onto the stud bolts.
- 3) Align both the end of the valves stacked.
- 4) Screw-in the four nuts onto the stud bolts and tighten with the specified torque. After the test run, be sure to re-tighten the nuts firmly within the specified torque.

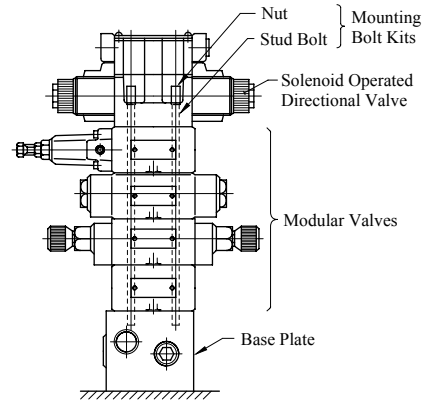

03 Series Modular Valves

⚠ CAUTION

- Keep all installation holes and surface clean. Failure to do this may cause fire due to oil leakage.
- Before installing the product, be sure that all specified bolts are tightened to the specified torque levels. Tightening to levels outside specifications may cause improper operation, damage, oil leakage, etc.

■ Pressure Drop

Pressure drop curves of the modular valves are those based on viscosity of 35 mm²/s (164 SSU) and specific gravity of 0.850.

When using the modular valves in conditions other than the above mentioned, find the appropriate values referring to the following table and formula.

- For any other viscosity, multiply the factors in the table below.

Viscosity	mm ² /s	15	20	30	40	50	60	70	80	90	100
	SSU		77	98	141	186	232	278	324	371	417
Factor		0.81	0.87	0.96	1.03	1.09	1.14	1.19	1.23	1.27	1.30

- For any other specific gravity (G'), the pressure drop ($\Delta P'$) may be obtained from the following formula.

$$\Delta P' = \Delta P (G'/0.850)$$

■ Specifications

Model Numbers	Max. Operating Pressure MPa (PSI)	Max. Flow L/min (U.S.GPM)
MBP-03-* -30/3090 MBA-03-* -30/3090 MBB-03-* -30/3090 MBW-03-* -30/3090	31.5 (4570)	70 (18.5)

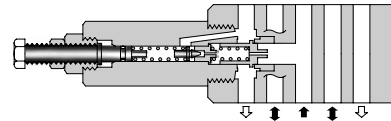

■ Model Number Designation

F-	MBA	-03	-B	-30	*
Special Seals	Series Number	Valve Size	Pres. Adj. Range MPa (PSI)	Design Number	Design Standard
F: Special Seals for Phosphate Ester Type Fluids (Omit if not required)	MBP : Relief Valve for P-Line MBA : Relief Valve for A-Line MBB : Relief Valve for B-Line MBW : Relief Valve for A&B-Lines	03	B : *-7 * ¹ (*-1020) H : 3.5-25 (510-3630)	30	Refer to ★ ²

★ 1. See the "Minimum Adjustment Pressure" of the next page for the item marked *.

★ 2. Design Standards: None Japanese Standard "JIS" and European Design Standard
 90 N. American Design Standard

■ Instructions

- The minimum adjustment pressure equals the value obtained from the minimum adjustment pressure characteristics plus the tank line back pressure of the next page. This back pressure should include the value of the T-line pressure drop characteristics of the valves stacked to the base plate side of the modular valve.
- To make pressure adjustment, loosen the lock nut and turn the pressure adjustment screw clockwise or anti-clockwise. For an increase of pressure, turn the screw clockwise. Be sure to re-tighten the lock nut firmly after making adjustment to the pressure.
- In case of a small flow, the setting pressure may become unstable. To avoid this, refer to the minimum flow characteristic curve of the next page and use the valve within a range as shown with .

Model Numbers	Graphic Symbols	Detailed Graphic Symbols
MBP-03		
MBA-03		
MBB-03		
MBW-03		



Hydraulic Fluid: Viscosity 35 mm²/s (164 SSU), Specific Gravity 0.850

Nominal Override Characteristics

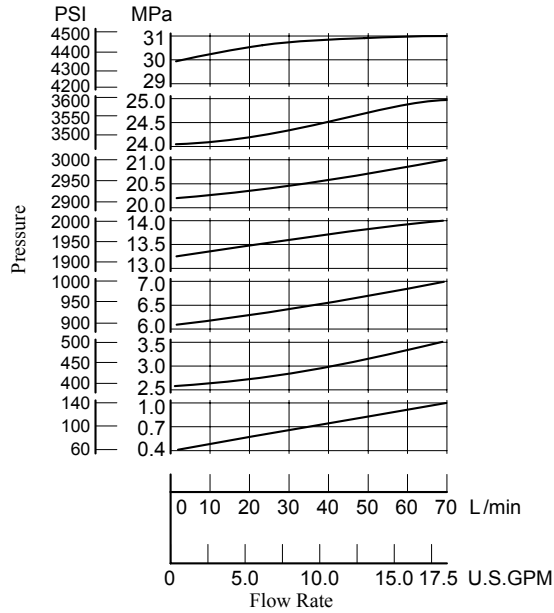

Min. Adjustment Pressure

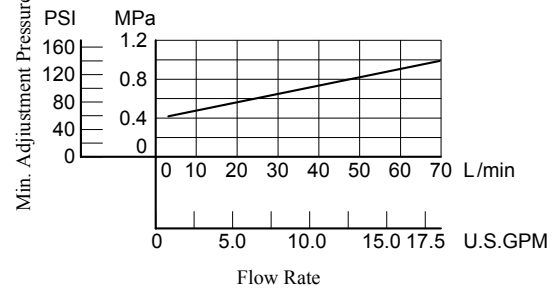

Min. Flow vs. Adjustment Pressure

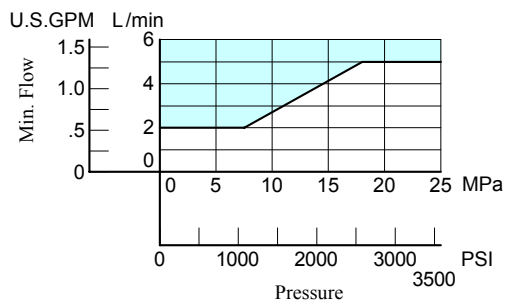

Pressure Drop

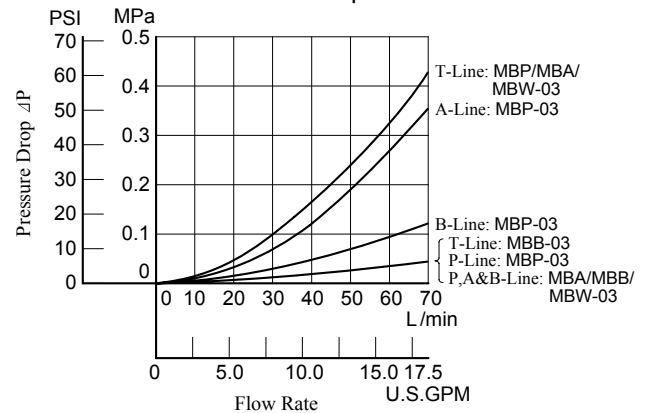

MBW-03-* -30/3090

DIMENSIONS IN
MILLIMETRES (INCHES)

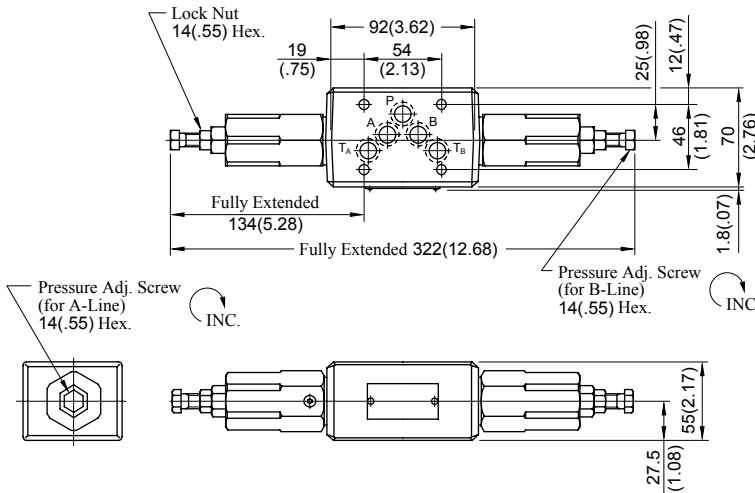

Approx. Mass..... 4.2 kg (9.3 lbs.)

MBP-03-* -30/3090
MBA-03-* -30/3090

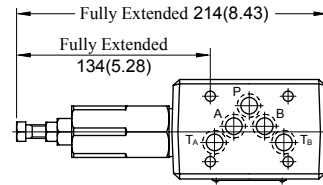

Approx. Mass..... 3.5 kg (7.7 lbs.)

• For other dimensions, refer to "MBW-03" drawing left.

MBB-03-* -30/3090

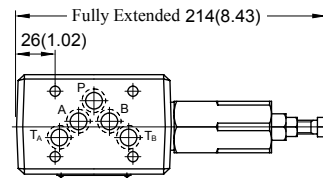

Approx. Mass..... 3.5 kg (7.7 lbs.)

• For other dimensions, refer to "MBW-03" drawing left.

■ Spare Parts List

MBP-03-* -30/3090
MBA-03-* -30/3090

MBB-03-* -30/3090

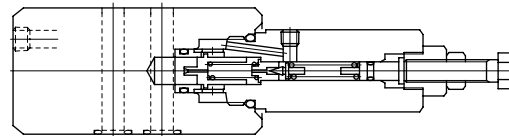
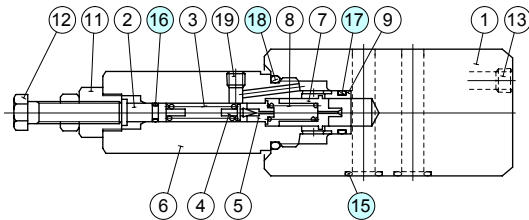

MBW-03-* -30/3090

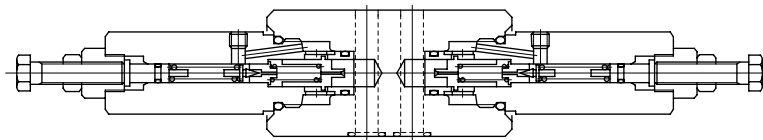

● List of Seals

Item	Name of Parts	Part Numbers	Quantity			
			MBP-03	MBA-03	MBB-03	MBW-03
15	O-Ring	SO-NB-A014	5	5	5	5
16	O-Ring	SO-NA-P6	1	1	1	2
17	O-Ring	SO-NB-P16	1	1	1	2
18	O-Ring	SO-NB-P26	1	1	1	2

Note: When ordering seals, please specify the seal kit number from the table right.

● List of Seal Kits

Model Numbers	Seal kit Numbers
MBP-03	KS-MBP-03-30
MBA-03	
MBB-03	
MBW-03	

⚠ CAUTION

When making replacement of seals, please do it carefully after reading through the relevant instructions in the Operator's Manual.

■ Specifications

Model Numbers	Max. Operating Pressure MPa(PSI)	Max. Flow L/min (U.S.GPM)
MRP-03-* -30/3090 MRA-03-* -30/3090 MRB-03-* -30/3090	25 (3630)	70 (18.5) *

★ In pressure adjustment range "H", if the pressure in the primary side is set above 20 MPa (2900 PSI) and the pressure in the secondary side is set below 10 MPa (1450 PSI), the maximum flow is limited to 50 L/min (13.2 U.S.GPM).

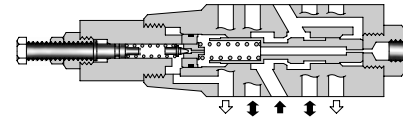

■ Model Number Designation

F-	MRP	-03	-B	-30	*
Special Seals	Series Number	Valve Size	Pres. Adj. Range MPa (PSI)	Design Number	Design Standard
F: Special Seals for Phosphate Ester Type Fluids (Omit if not required)	MRP: Reducing Valve for P-Line MRA: Reducing Valve for A-Line MRB: Reducing Valve for B-Line	03	B: 1-7 (145-1020) H: 3.5-24.5 (510-3550)	30	Refer to ★

★ Design Standards: None Japanese Standard "JIS" and European Design Standard
 90 N. American Design Standard

■ Instructions

- The minimum adjustment pressure equals the lower limit of either pressure adjustment range (B, H) plus the tank line back pressure of the next page. This back pressure should include the value of the T-line pressure drop characteristics of the valves stacked to the base plate side of the modular valve.
- To make pressure adjustment, loosen the lock nut and turn the pressure adjustment screw clockwise or anti-clockwise. For an increase of pressure, turn the screw clockwise. Be sure to re-tighten the lock nut firmly after making adjustment to the pressure.

Model Numbers	Graphic Symbols	Detailed Graphic Symbols
MRP-03		
MRA-03		
MRB-03		

Hydraulic Fluid: Viscosity 35 mm²/s (164 SSU), Specific Gravity 0.850

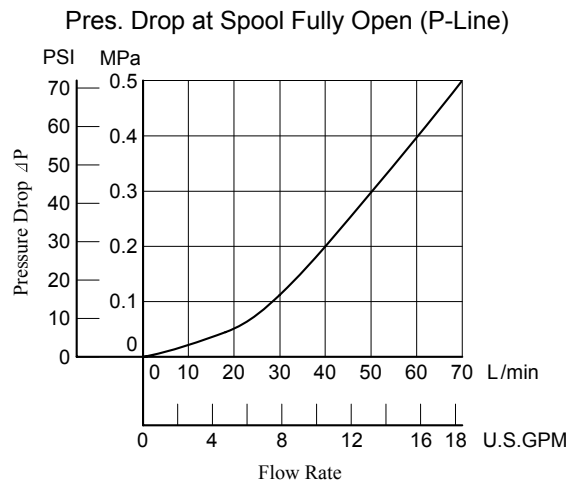
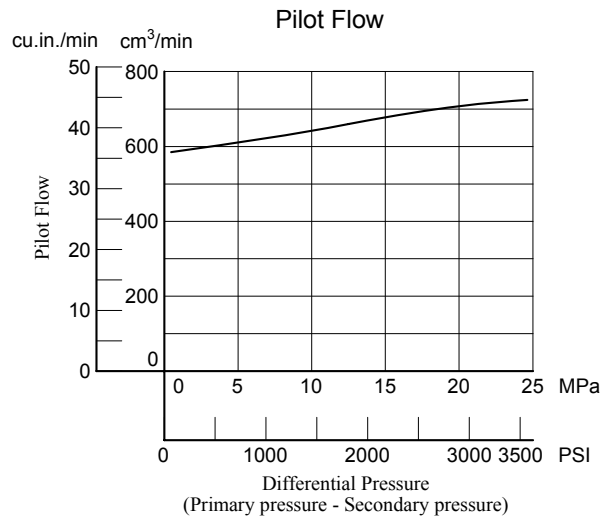
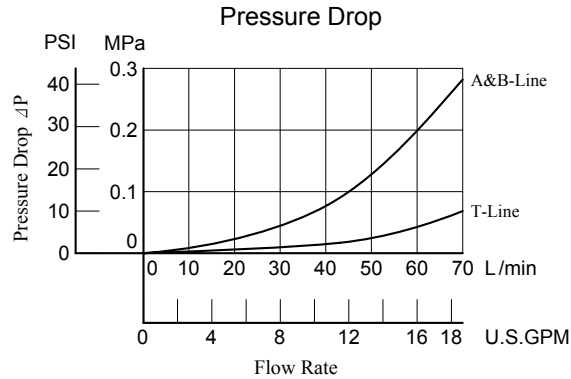

MRP-03-* -30/3090

MRB-03-* -30/3090

**DIMENSIONS IN
MILLIMETRES (INCHES)**

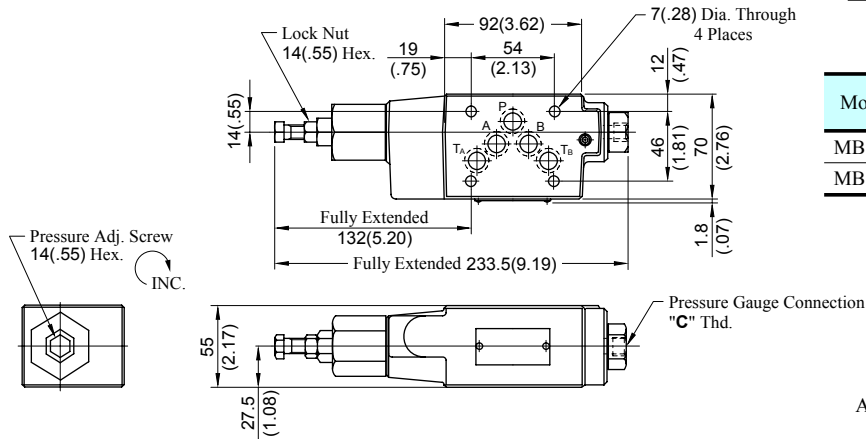

Model Numbers	Thread Size "C" Thd.
MB*-01-* -30	Rc 1/4 = 1/4 BSP.Tr
MB*-01-* -3090	1/4 NPT

Approx. Mass..... 3.8 kg (8.4 lbs.)

MRA-03-* -30/3090

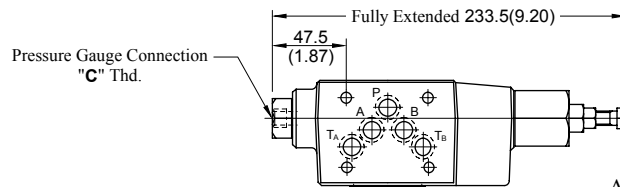

Approx. Mass..... 3.8 kg (8.4 lbs.)

• For other dimensions, refer to "MRP-03" drawing above.

■ Spare Parts List

MRP-03-* -30/3090

MRB-03-* -30/3090

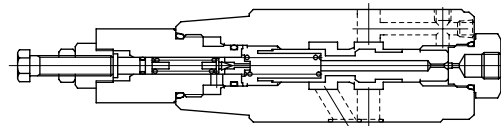
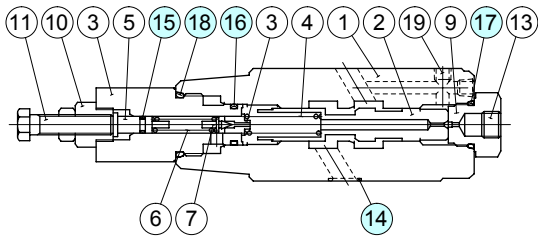

MRA-03-* -30/3090

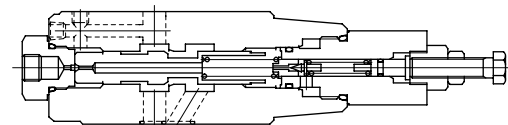

● List of Seals

Item	Name of Parts	Part Numbers	Qty.	Remarks
14	O-Ring	SO-NB-A014	5	Included in Seal Kit Kit No.: KS-MRP-03-30
15	O-Ring	SO-NA-P6	1	
16	O-Ring	SO-NB-P16	1	
17	O-Ring	SO-NB-P18	1	
18	O-Ring	SO-NB-P26	1	

⚠ CAUTION

When making replacement of seals, please do it carefully after reading through the relevant instructions in the Operator's Manual.

Specifications

Model Numbers	Max. Operating Pressure MPa (PSI)	Pres. Adj. Range MPa (PSI)	Max. Flow L/min (U.S.GPM)
MRLP-03-10/1080/1090 MRLA-03-10/1080/1090 MRLB-03-10/1080/1090	7 (1020)	0.2-6.5 (29-940)	50 (13.2) *

★ When pressure setting is less than 0.8 MPa (116 PSI), maximum pressure decreases. See "Min. Adjustment Pressure vs. Max. Flow" on the next page for the appropriate range.

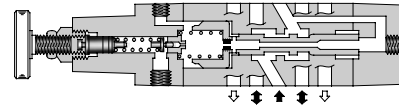

Model Number Designation

F-	MRLP	-03	-10	*
Special Seals	Series Number	Valve Size	Design Number	Design Standard
F: Special Seals for Phosphate Ester Type Fluids (Omit if not required)	MRLP : Low Pressure Setting Type Reducing Valve for P-Line MRLA : Low Pressure Setting Type Reducing Valve for A-Line MRLB : Low Pressure Setting Type Reducing Valve for B-Line	03	10	Refer to ★

★ Design Standards: None Japanese Standard "JIS"
 80 European Design Standard
 90 N. American Design Standard

Instructions

- If there is a pressure in drain line, it is added to the secondary setting pressure. Hence, drain line must be connected to tank directly with a low back pressure close to atmospheric pressure.
- To make pressure adjustment, loosen the lock nut and turn the pressure adjustment handle clockwise or anti-clockwise. For an increase of pressure, turn the handle clockwise. Be sure to re-tighten the lock nut firmly after making adjustment to the pressure.

Model Numbers	Graphic Symbols	Detailed Graphic Symbols
MRLP-03		
MRLA-03		
MRLB-03		



Typical Performance Characteristics

Hydraulic Fluid: Viscosity 35 mm²/s (164 SSU), Specific Gravity 0.850

Pres. Drop at Spool Fully Open (P-Line)

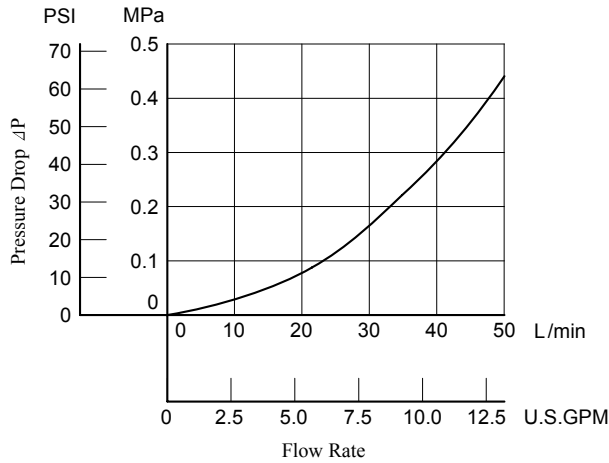

Pressure Drop

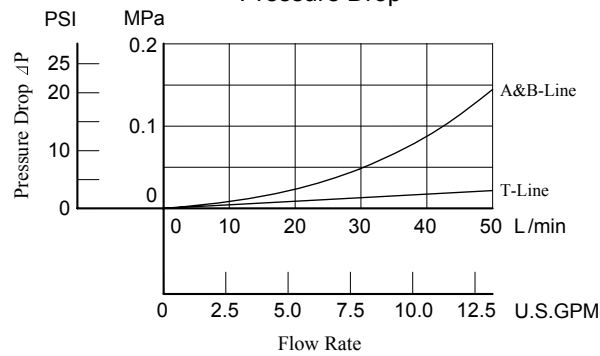

Min. Adjustment Pressure vs. Max. Flow

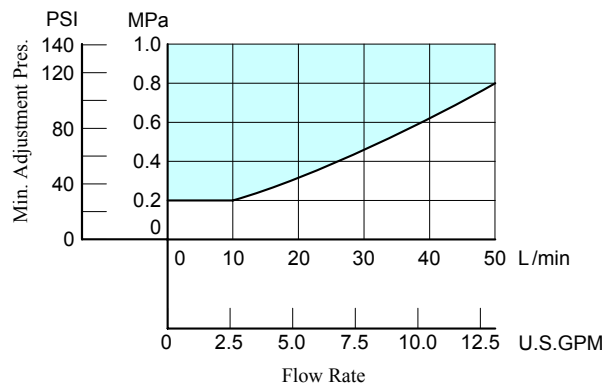

Installation Drawing

MRLP-03-10/1080/1090
MRLB-03-10/1080/1090

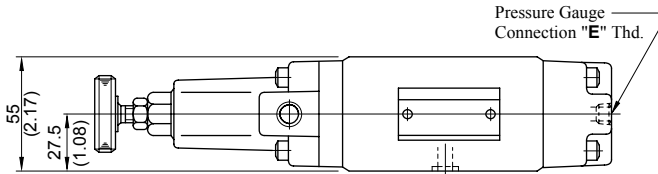
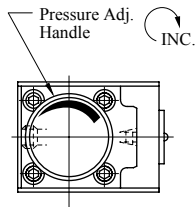
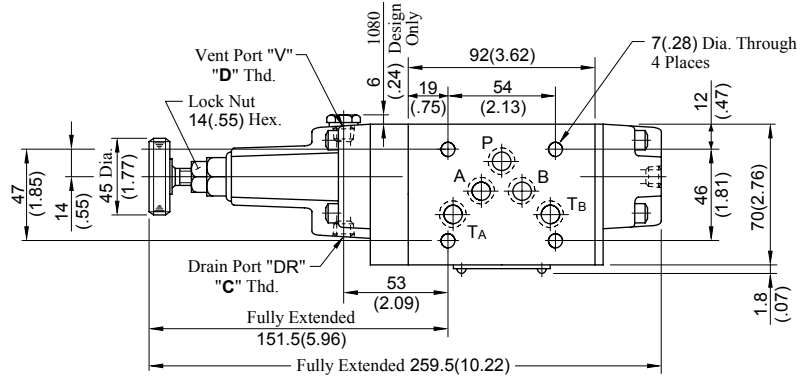

Approx. Mass..... 4.5 kg (9.9 lbs.)

Model Numbers	Thread Size		
	"C" Thd.	"D" Thd.	"E" Thd.
MRL*-03-10	Rc 1/4	Rc 1/8	Rc 1/4
MRL*-03-1080	1/4 BSP.F	1/8 BSP.F	1/4 BSP.Tr
MRL*-03-1090	1/4 NPT	1/8 NPT	1/4 NPT

DIMENSIONS IN
MILLIMETRES (INCHES)

MRLA-03-10/1080/1090

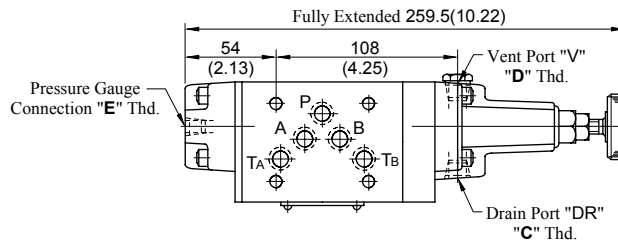

Approx. Mass..... 4.5 kg (9.9 lbs.)

- For other dimensions, refer to "MRLP-03" drawing above.



Spare Parts List

■ Spare Parts List

MRLP-03-10/1080/1090

MRLB-03-10/1080/1090

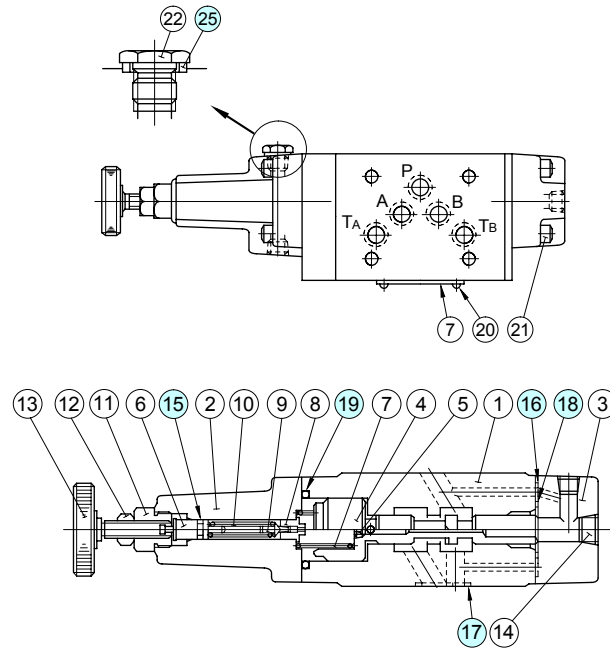

MRLA-03-10/1080/1090

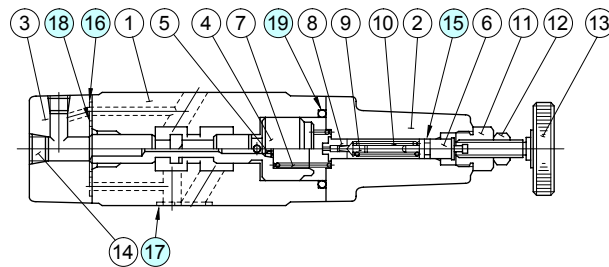

● List of Seals

Item	Name of Parts	Part Numbers	Qty.	Remarks
15	O-Ring	SO-NA-P6	1	Included in Seal Kit Kit No.:KS-MRLP-03-10
16	O-Ring	SO-NB-P6	2	
17	O-Ring	SO-NB-A014	5	
18	O-Ring	SO-NB-P22	1	
19	O-Ring	SO-NB-P32	1	
25	Bonded Seal	SG-FB-1/8	1	

Note: No bonded seal are included in seal kits.



CAUTION

When making replacement of seals, please do it carefully after reading through the relevant instructions in the Operator's Manual.

■ Specifications

Model Numbers	Max. Operating Pressure MPa (PSI)	Max. Flow L/min (U.S.GPM)	Max. Free Flow L/min (U.S.GPM)
MHP-03-*-20/2090	25 (3630)	50 (13.2)	—
MHA-03-*-20/2090			70 (18.5)
MHB-03-*-20/2090			70 (18.5)

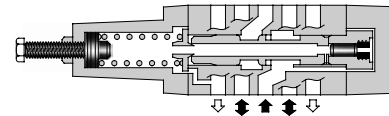

MHP-03

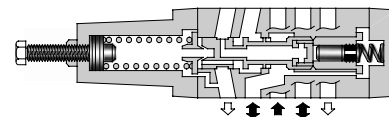

MHA/MHB-03



■ Model Number Designation

F-	MHA	-03	-C	-20	*
Special Seals	Series Number	Valve Size	Pres. Adj. Range MPa (PSI)	Design Number	Design Standard
F: Special Seals for Phosphate Ester Type Fluids (Omit if not required)	MHP: Sequence Valve for P-Line	03	N: *-1.8 (*-260) * ¹ A: 1.8-3.5 (260-510) B: 3.5-7 (510-1020) C: 7-14 (1020-2030)	20	Refer to ★ ²
	MHA: Counterbalance Valve for A-Line MHB: Counterbalance Valve for B-Line			20	

★ 1. See the "Minimum Adjustment Pressure" of the next page for the item marked *.

★ 2. Design Standards: None Japanese Standard "JIS" and European Design Standard
 90 N. American Design Standard

■ Instructions

- The minimum adjustment pressure equals the value obtained from the minimum adjustment pressure characteristics plus the tank line back pressure of the next page. This back pressure should include the value of the T-line pressure drop characteristics of the valves stacked to the base plate side of the modular valve.
- To make pressure adjustment, loosen the lock nut and turn the pressure adjustment screw clockwise or anti-clockwise. For an increase of pressure, turn the screw clockwise. Be sure to re-tighten the lock nut firmly after making adjustment to the pressure.

Model Numbers	Graphic Symbols	Detailed Graphic Symbols
MHP-03		
MHA-03		
MHB-03		



3/8, Sequence Modular Valves For "P" Line 3/8, Counterbalance Modular Valves For "A" and "B" Lines

MODULAR VALVES

Typical Performance Characteristics

Hydraulic Fluid: Viscosity 35 mm²/s (164 SSU), Specific Gravity 0.850

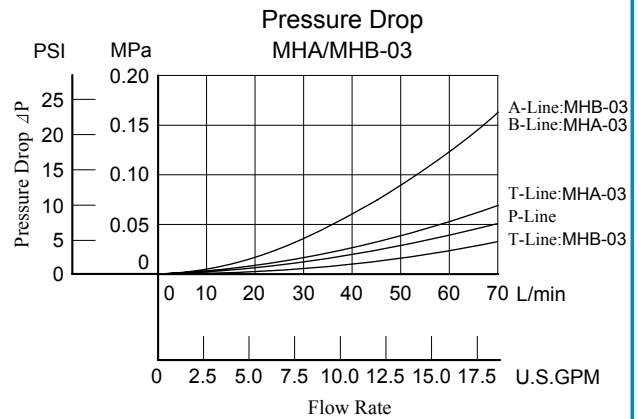
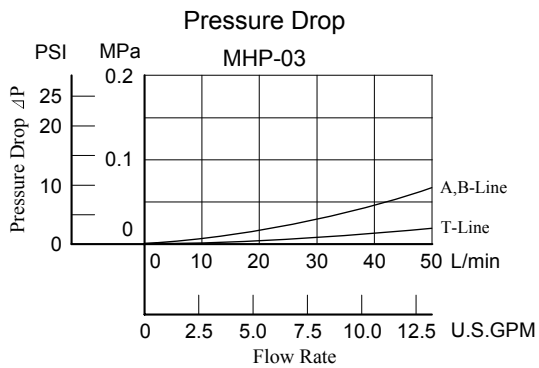
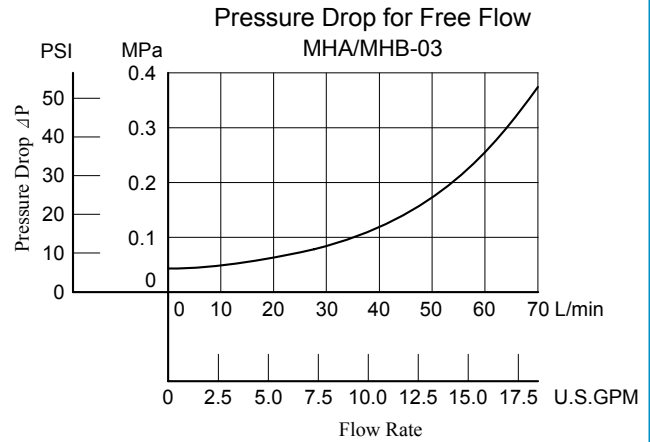
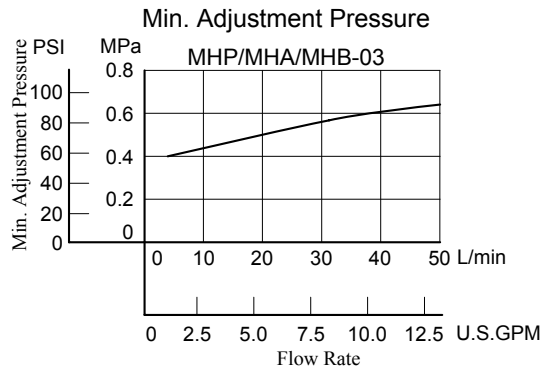

MHP-03-* -20/2090

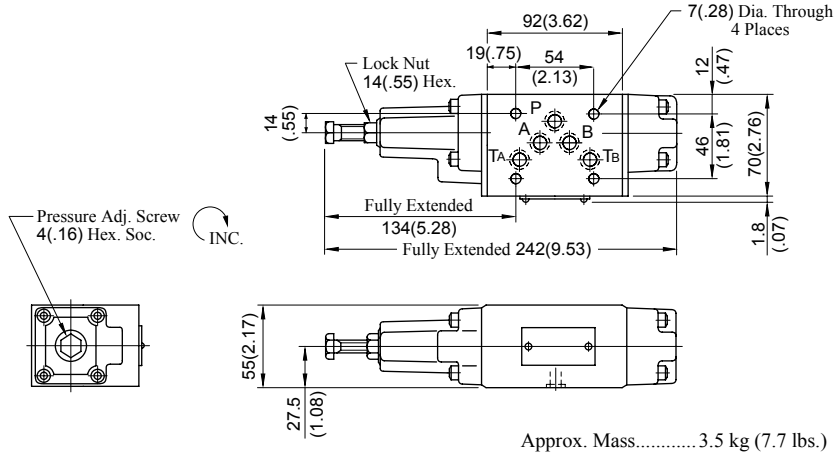

DIMENSIONS IN
MILLIMETRES (INCHES)

MHA-03-* -20/2090

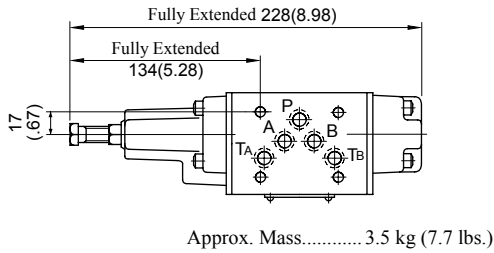

MHB-03-* -20/2090

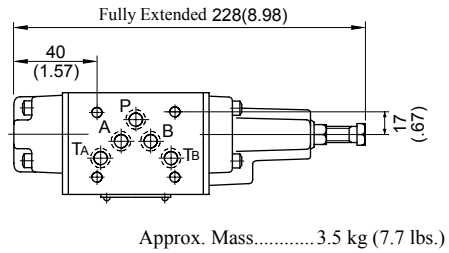

• For other dimensions, refer to "MHP-03" drawing above.

■ Spare Parts List

MHP-03-* -20/2090

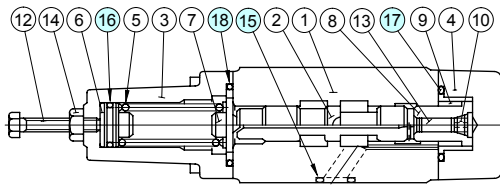

⚠ CAUTION

When making replacement of seals, please do it carefully after reading through the relevant instructions in the Operator's Manual.

● List of Seals

Item	Name of Parts	Part Numbers	Qty.	Remarks
15	O-Ring	SO-NB-A014	5	Included in Seal Kit Kit No.:KS-MHP-03-20
16	O-Ring	SO-NA-P16	1	
17	O-Ring	SO-NB-P29	1	
18	O-Ring	SO-NB-P32	1	

MHA-03-* -20/2090

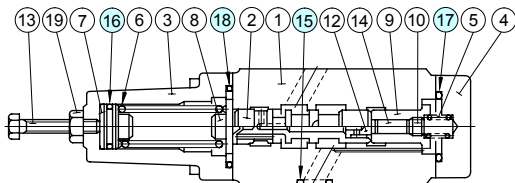

MHB-03-* -20/2090

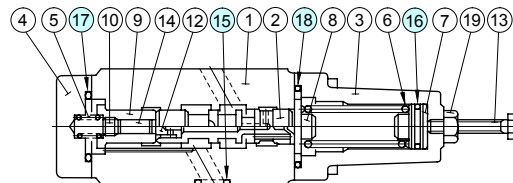



**Pressure and Temperature Compensated
3/8, Flow Control (and Check) Valves**
For "P" Line: MFP-03-11/1190
For "A" Line: MFA-03-* -11/1190
For "B" Line: MFB-03-* -11/1190
For "A&B" Lines: MFW-03-* -11/1190

**MODULAR
VALVES**

Specifications / Others

■ Specifications

Model Numbers	Max. Operating Pressure MPa (PSI)	Max. Metred Flow L/min (U.S.GPM)	Max. Free Flow L/min (U.S.GPM)
MFP-03-11/1190	16 (2320)	50 (13.2)	—
MFA-03-* -11/1190			70 (18.5)
MFB-03-* -11/1190			
MFW-03-* -11/1190			

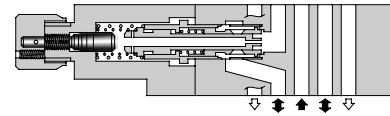

■ Model Number Designation

F-	MFA	-03	-X	-11	*
Special Seals	Series Number	Valve Size	Direction of Flow	Design Number	Design Standard
F: Special Seals for Phosphate Ester Type Fluids (Omit if not required)	MFP : Flow Control Valve for P-Line MFA : Flow Control and Check Valve for A-Line MFB : Flow Control and Check Valve for B-Line MFW : Flow Control and Check Valve for A&B-Lines	03	— X : Metre-out Y : Metre-in	11 11	Refer to ★

★ Design Standards: None Japanese Standard "JIS" and European Design Standard 90 N. American Design Standard

■ Instructions

- To make flow rate adjustment, loosen locking screw for the dial and turn the flow adjustment dial clockwise or anti-clockwise. For a decrease of flow, turn the dial clockwise. Be sure to re-tighten the locking screw firmly after the adjustment of the flow rate.

Model No.	Graphic Symbols	Detailed Graphic Symbols	Model No.	Graphic Symbols	Detailed Graphic Symbols
MFP-03					
	Metre-out			Metre-in	
MFA-03-X			MFA-03-Y		
MFB-03-X			MFB-03-Y		
MFW-03-X			MFW-03-Y		

Typical Performance Characteristics

Hydraulic Fluid: Viscosity 35 mm²/s (164 SSU), Specific Gravity 0.850

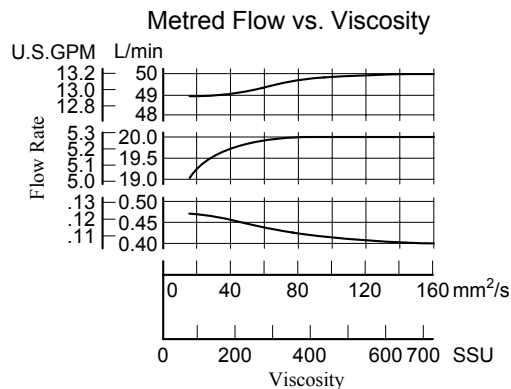
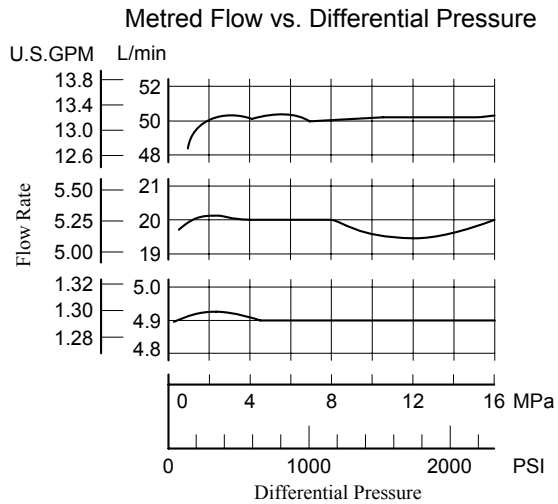
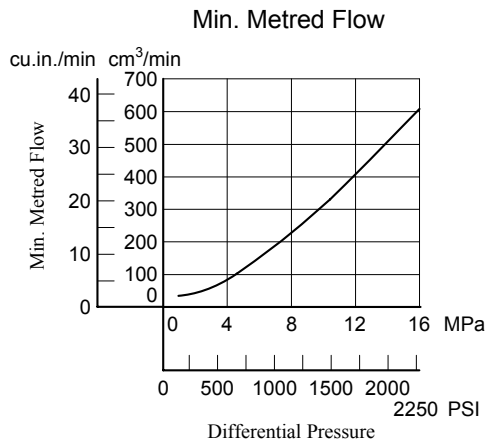
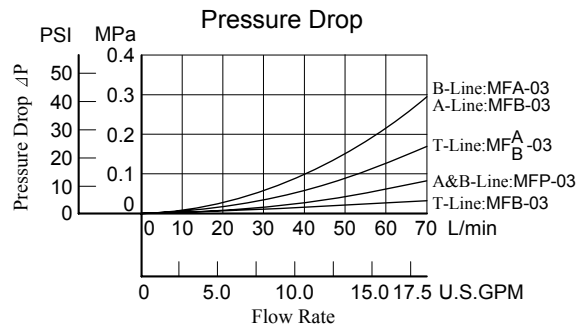
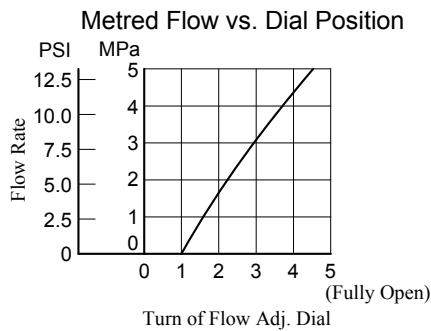
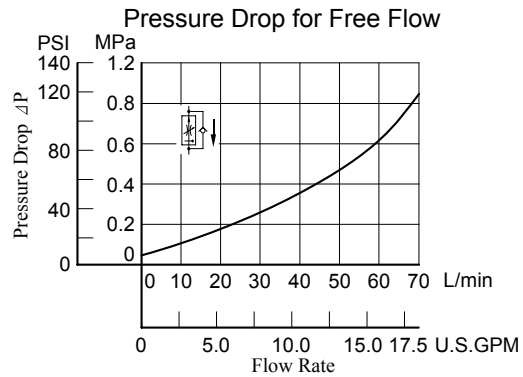
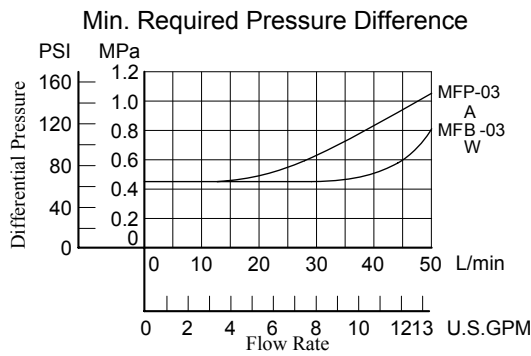

Installation Drawing

MFP-03-11/1190

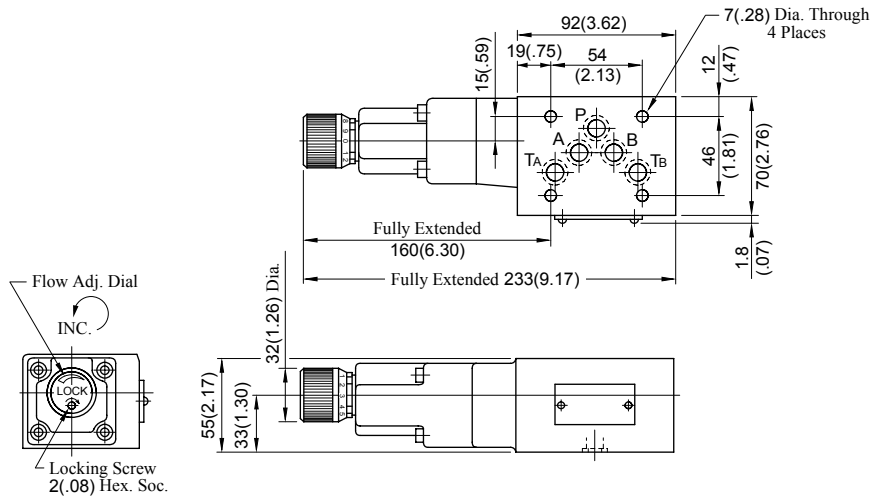

Approx. Mass..... 4.2 kg (9.3 lbs.)

MFW-03-X-11/1190

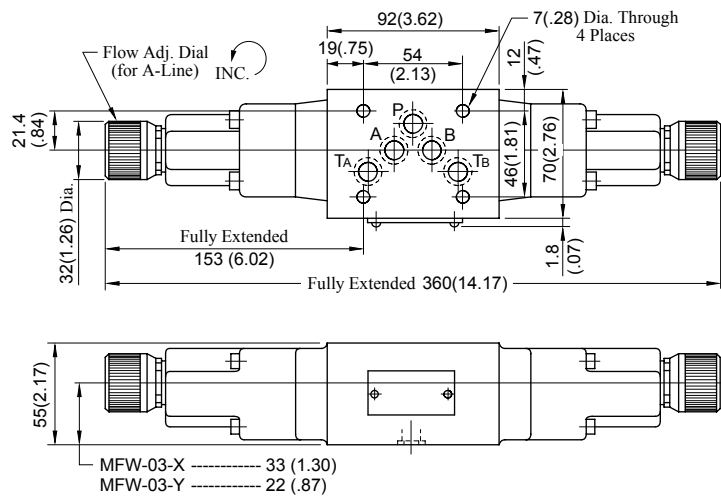

DIMENSIONS IN
MILLIMETRES (INCHES)

Approx. Mass..... 5.2 kg (11.5 lbs.)

MFA-03-X-11/1190

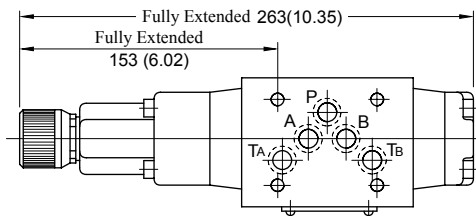

Approx. Mass..... 4.1 kg (9.0 lbs.)

MFB-03-X-11/1190

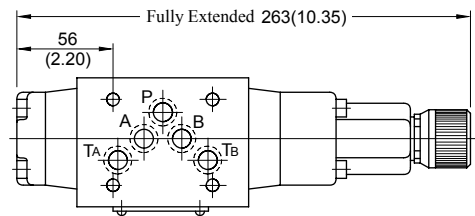

Approx. Mass..... 4.1 kg (9.0 lbs.)

• For other dimensions, refer to "MFW-03" drawing above.

Spare Parts List

■ Spare Parts List

MFP-03-11/1190

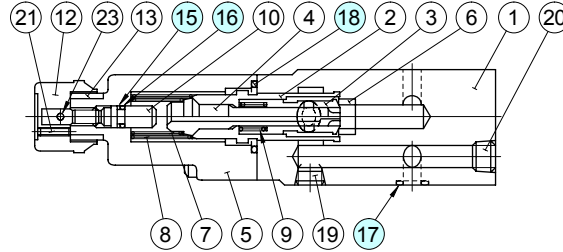

MFA-03-~~X~~-11/1190

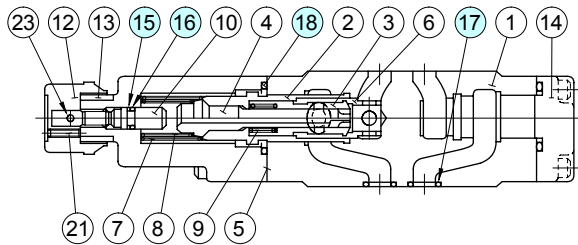

MFB-03-~~X~~-11/1190

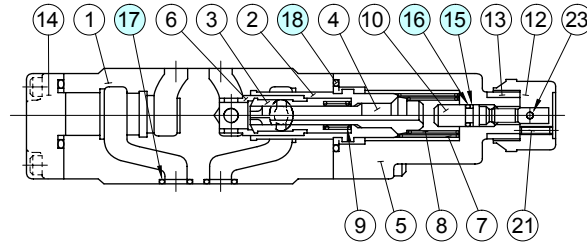

MFW-03-~~X~~-11/1190

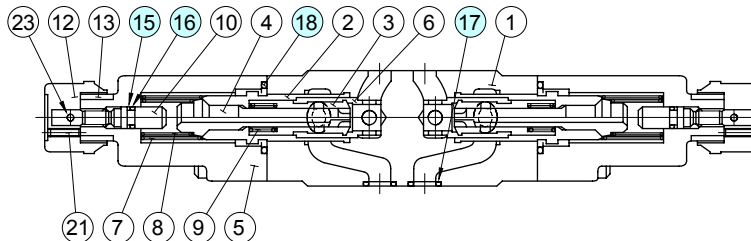

● List of Seals

Item	Name of Parts	Part Numbers	Quantity			
			MFP-03	MFA-03	MFB-03	MFW-03
15	Back Up Ring	SO-BB-P6	1	1	1	2
16	O-Ring	SO-NA-P6	1	1	1	2
17	O-Ring	SO-NB-A014	5	5	5	5
18	O-Ring	SO-NB-P28	1	2	2	2

● List of Seal Kits

Model Numbers	Seal Kit Numbers
MFP-03	KS-MFP-03-10
MFA-03	KS-MFA-03-10
MFB-03	
MFW-03	KS-MFW-03-10

Note: When ordering seals, please specify the seal kit number from the table right.

⚠ CAUTION

When making replacement of seals, please do it carefully after reading through the relevant instructions in the Operator's Manual.



■ Specifications

Model Numbers	Max. Operating Pressure MPa (PSI)	Max. Differential Pressure MPa (PSI)	Max. Metred Flow L/min (U.S.GPM)	Min. Metred Flow L/min (U.S.GPM)	Max. Free Flow L/min (U.S.GPM)
MSTA-03-X-20/2090 MSTB-03-X-20/2090 MSTW-03-X-20/2090	25 (3630)	25 (3630)	70 (18.5)	2 (.53) {1 (.26)}*	70 (18.5)

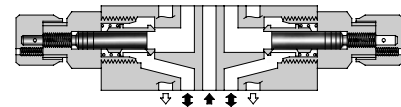

★ The figures in parentheses are the values when the differential pressure is less than 3.5 MPa (510 PSI).

■ Model Number Designation

F-	MSTA	-03	-X	-20	*
Special Seals	Series Number	Valve Size	Direction of Flow	Design Number	Design Standard
F: Special Seals for Phosphate Ester Type Fluids (Omit if not required)	MSTA : Temperature Compensated Throttle and Check Valve for A-Line MSTB : Temperature Compensated Throttle and Check Valve for B-Line MSTW : Temperature Compensated Throttle and Check Valve for A&B-Lines	03	X : Metre-out	20	Refer to ★

★ Design Standards: None Japanese Standard "JIS" and European Design Standard 90 N. American Design Standard

■ Instructions

- To make flow rate adjustment, loosen locking screw for the dial and turn the flow adjustment dial clockwise or anti-clockwise. For a decrease of flow, turn the dial clockwise. Be sure to re-tighten the locking screw firmly after the adjustment of the flow rate.

Model No.	Graphic Symbols	Detailed Graphic Symbols
	Metre-out	
MSTA-03-X		
MSTB-03-X		
MSTW-03-X		

Typical Performance Characteristics

Hydraulic Fluid: Viscosity 35 mm²/s (164 SSU), Specific Gravity 0.850

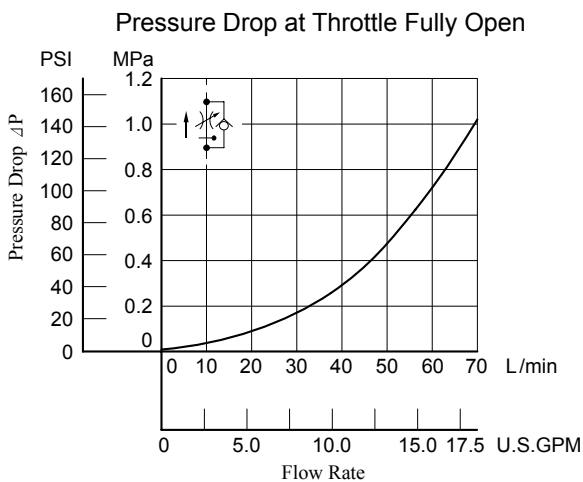
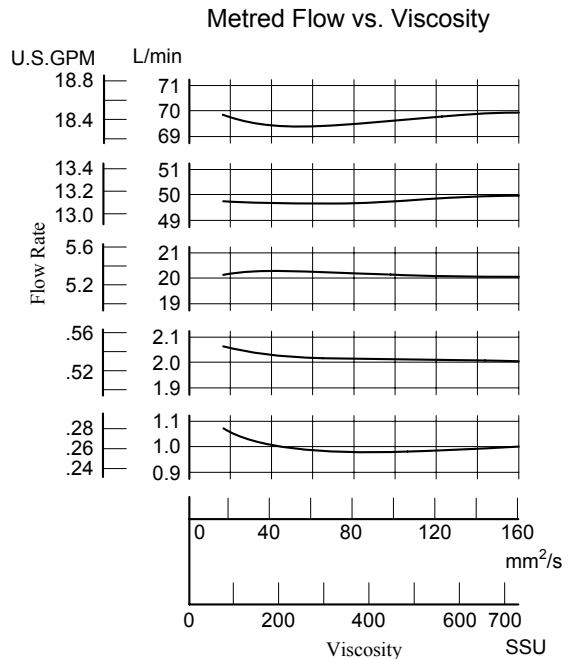
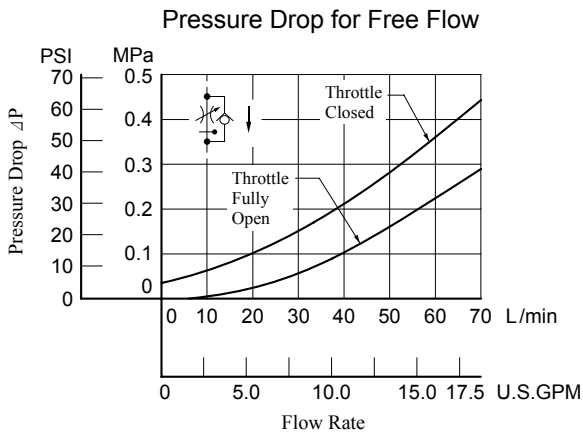
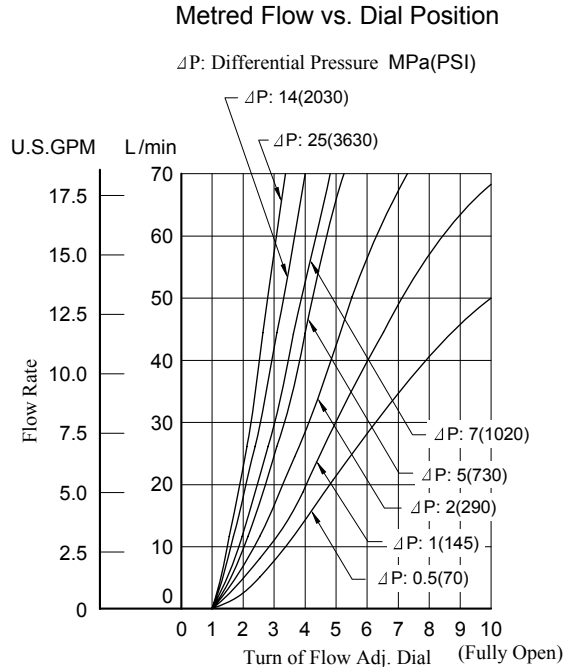
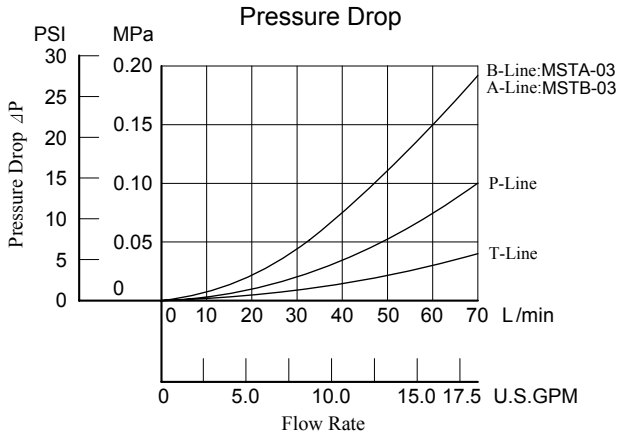

MSTW-03-X-20/2090

**DIMENSIONS IN
MILLIMETRES (INCHES)**

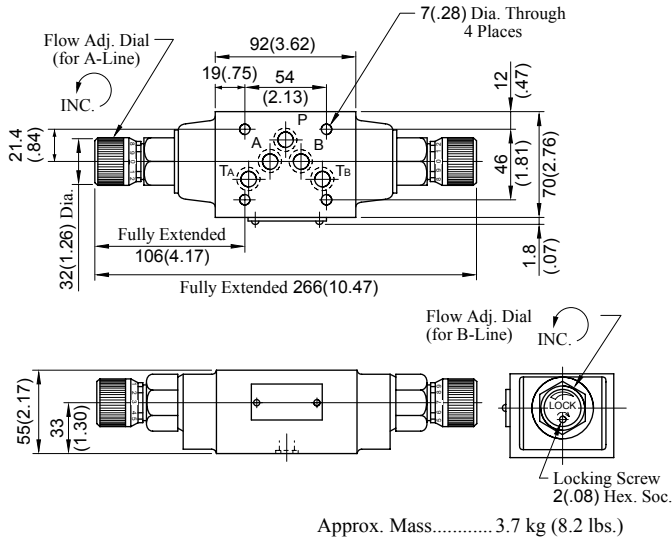

MSTA-03-X-20/2090

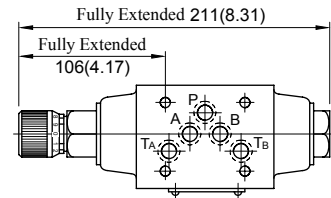

Approx. Mass..... 3.5 kg (7.7 lbs.)

• For other dimensions, refer to "MSTW-03" drawing left.

MSTB-03-X-20/2090

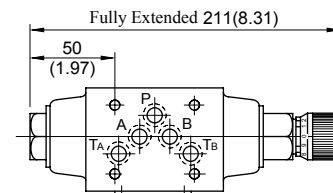

Approx. Mass..... 3.5 kg (7.7 lbs.)

• For other dimensions, refer to "MSTW-03" drawing left.

■ Spare Parts List

MSTA-03-X-20/2090

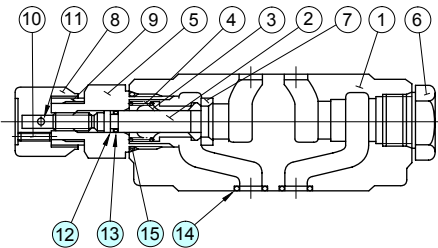

MSTB-03-X-20/2090

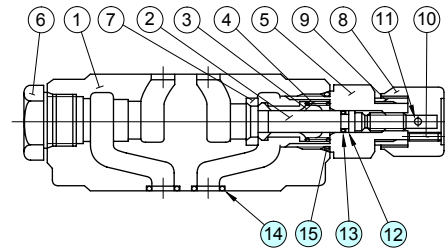

MSTW-03-X-20/2090

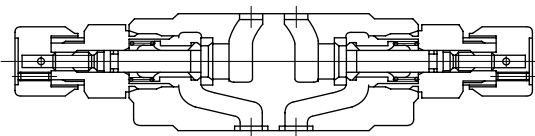

● List of Seals

Item	Name of Parts	Part Numbers	Quantity		
			MSTA-03	MSTB-03	MSTW-03
12	Back Up Ring	900-VK411915-2	1	1	2
13	O-Ring	SO-NA-P7	1	1	2
14	O-Ring	SO-NB-A014	5	5	5
15	O-Ring	SO-NB-P24	2	2	2

Note: When ordering seals, please specify the seal kit number from the table right.

● List of Seal Kits

Model Numbers	Seal Kit Numbers
MSTA-03	KS-MSTA-03-20
MSTB-03	
MSTW-03	KS-MSTW-03-20

⚠ CAUTION

When making replacement of seals, please do it carefully after reading through the relevant instructions in the Operator's Manual.

Specifications

Model Numbers	Max. Operating Pressure MPa (PSI)	Max. Flow L/min (U.S.GPM)
MSP-03-30/3090	25 (3630)	70 (18.5) *

★ Maximum flow decreases when the differential pressure is less than 1 MPa (145 PSI).
See "Pressure Drop at Throttle Fully Open".

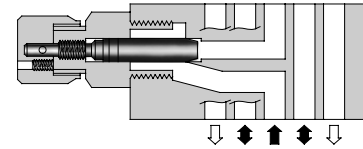

Model Number Designation

F-	MSP	-03	-30	*
Special Seals	Series Number	Valve Size	Design Number	Design Standard
F: Special Seals for Phosphate Ester Type Fluids (Omit if not required)	MSP: Throttle Valve for P-Line	03	30	Refer to ★

★ Design Standards: None Japanese Standard "JIS" and European Design Standard
90 N. American Design Standard

Graphic Symbol

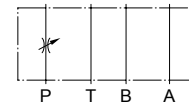

Detailed Graphic Symbol

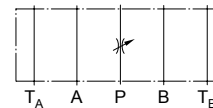

Typical Performance Characteristics

Hydraulic Fluid: Viscosity 35 mm²/s (164 SSU), Specific Gravity 0.850

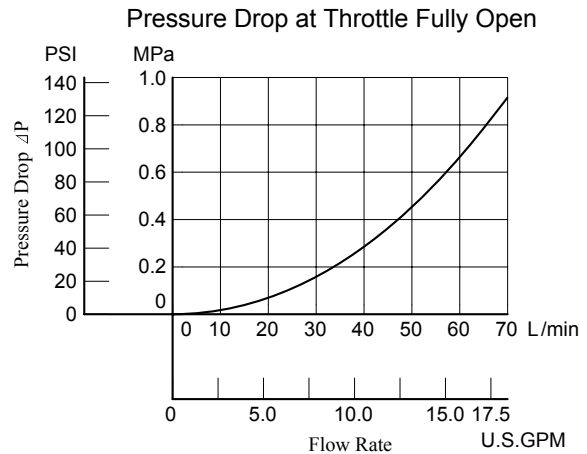
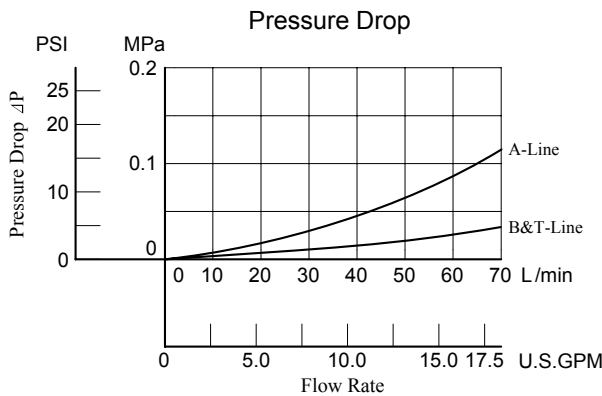

Metred Flow vs. Dial Position

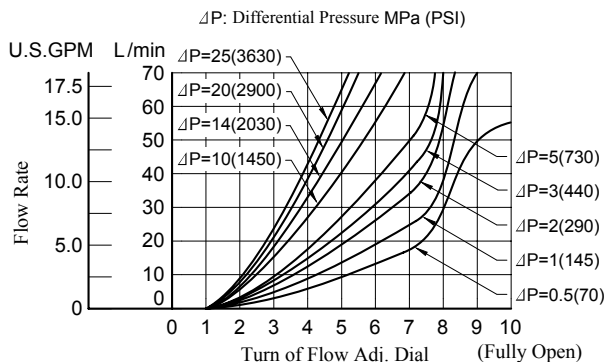

Instructions

- To make flow rate adjustment, loosen locking screw for the dial and turn the flow adjustment dial clockwise or anti-clockwise. For a decrease of flow, turn the dial clockwise. Be sure to re-tighten the locking screw firmly after the adjustment of the flow rate.



MSP-03-30/3090

DIMENSIONS IN
MILLIMETRES (INCHES)

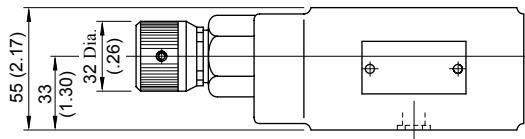
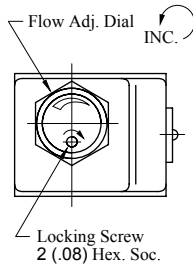
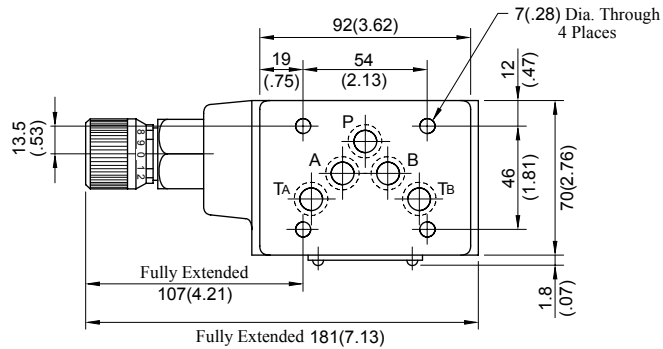

Approx. Mass..... 3.0 kg (6.6 lbs.)

■ Spare Parts List

MSP-03-30/3090

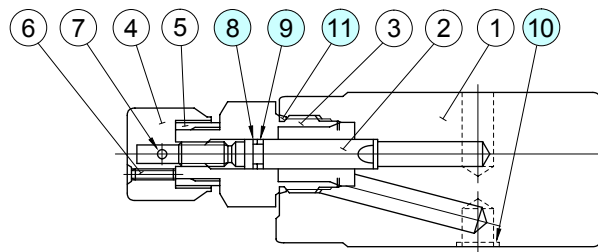

● List of Seals

Item	Name of Parts	Part Numbers	Qty.	Remarks
8	Back Up Ring	900-VK411915-2	1	Included in Seal Kit Kit No.: KS-MSP-03-30
9	O-Ring	SO-NA-P7	1	
10	O-Ring	SO-NB-A014	5	
11	O-Ring	SO-NB-P24	1	

⚠ CAUTION

When making replacement of seals, please do it carefully after reading through the relevant instructions in the Operator's Manual.

Specifications

Model Numbers	Max. Operating Pressure MPa (PSI)	Max. Flow L/min (U.S.GPM)
MSCP-03-20/2090	25 (3630)	70 (18.5)*

★ Maximum flow decreases when the differential pressure is less than 0.8 MPa (115 PSI).
See "Pressure Drop at Throttle Fully Open".

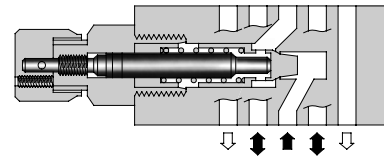

Model Number Designation

F-	MSCP	-03	-20	*
Special Seals	Series Number	Valve Size	Design Number	Design Standard
F: Special Seals for Phosphate Ester Type Fluids (Omit if not required)	MSCP : Check and Throttle Valve for P-Line	03	20	Refer to ★

★ Design Standards: None Japanese Standard "JIS" and European Design Standard
90 N. American Design Standard

Graphic Symbol

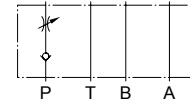

Detailed Graphic Symbol

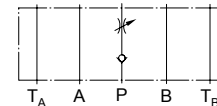

Typical Performance Characteristics

Hydraulic Fluid: Viscosity 35 mm²/s (164 SSU), Specific Gravity 0.850

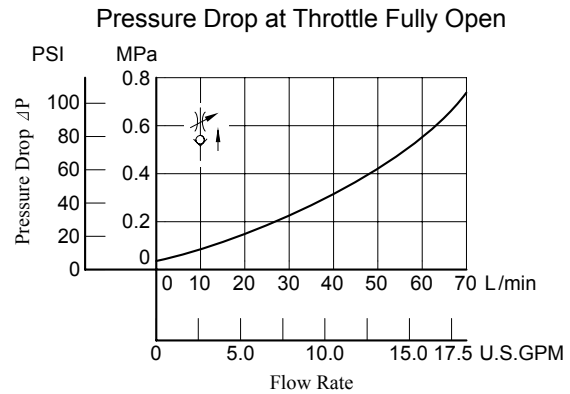
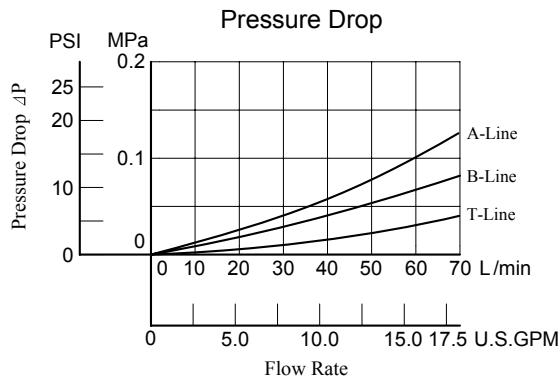

Metred Flow vs. Dial Position

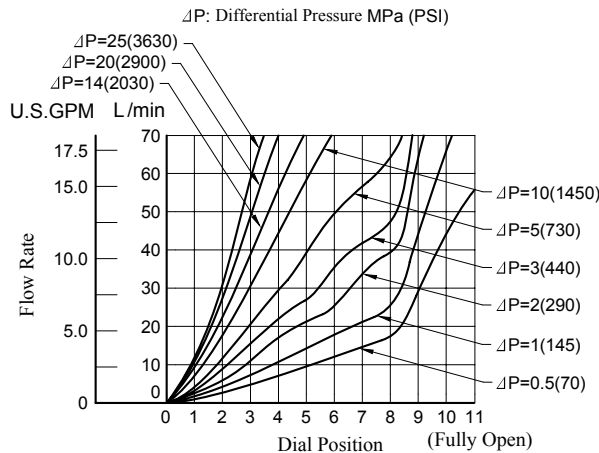

Instructions

- To make flow rate adjustment, loosen locking screw for the dial and turn the flow adjustment dial clockwise or anti-clockwise. For a decrease of flow, turn the dial clockwise. Be sure to re-tighten the locking screw firmly after the adjustment of the flow rate.



MSCP-03-20/2090

DIMENSIONS IN
MILLIMETRES (INCHES)

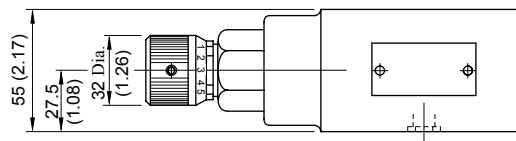
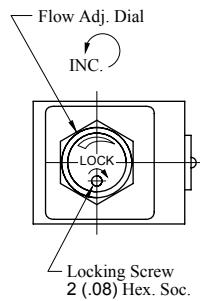
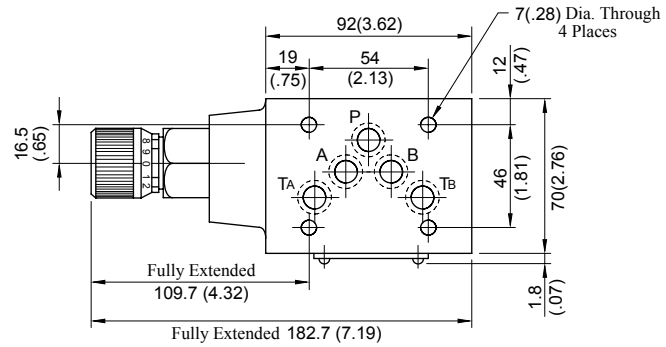

Approx. Mass..... 3.0 kg (6.6 lbs.)

■ Spare Parts List

MSCP-03-20/2090

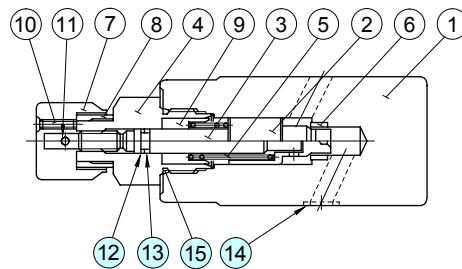

● List of Seals

Item	Name of Parts	Part Numbers	Qty.	Remarks
12	Back Up Ring	900-VK411915-2	1	Included in Seal Kit Kit No.: KS-MSP-03-30
13	O-Ring	SO-NA-P7	1	
14	O-Ring	SO-NB-A014	5	
15	O-Ring	SO-NB-P24	1	

⚠ CAUTION

When making replacement of seals, please do it carefully after reading through the relevant instructions in the Operator's Manual.

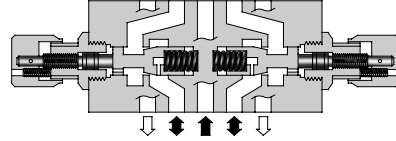

Specifications

Model Numbers	Max. Operating Pressure MPa (PSI)	Max. Flow L/min (U.S.GPM)
MSA-03-* -40/4090 MSB-03-* -40/4090 MSW-03-* -40/4090	31.5 (4570)	120 (31.7)

Model Number Designation

F-	MSW	-03	-X	-40	*
Special Seals	Series Number	Valve Size	Direction of Flow	Design Number	Design Standard
F: Special Seals for Phosphate Ester Type Fluids (Omit if not required)	MSA : Throttle and Check Valve for A-Line MSB : Throttle and Check Valve for B-Line MSW : Throttle and Check Valve for A&B-Lines	03	X : Metre-out Y : Metre-in	40	Refer to ★

★ Design Standards: None Japanese Standard "JIS" and European Design Standard
 90 N. American Design Standard

Instructions

- To make flow rate adjustment, loosen locking screw for the dial and turn the flow adjustment dial clockwise or anti-clockwise. For a decrease of flow, turn the dial clockwise. Be sure to re-tighten the locking screw firmly after the adjustment of the flow rate.

Model No.	Graphic Symbols	Detailed Graphic Symbols	Model No.	Metre-out	
				Graphic Symbols	Detailed Graphic Symbols
MSA-03-X			MSA-03-Y	Metre-in	
MSB-03-X			MSB-03-Y	Metre-in	
MSW-03-X			MSW-03-Y	Metre-in	



Hydraulic Fluid: Viscosity 35 mm²/s (164 SSU), Specific Gravity 0.850

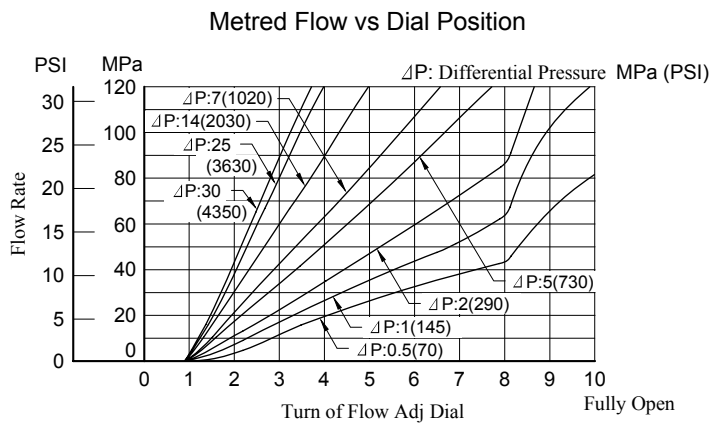
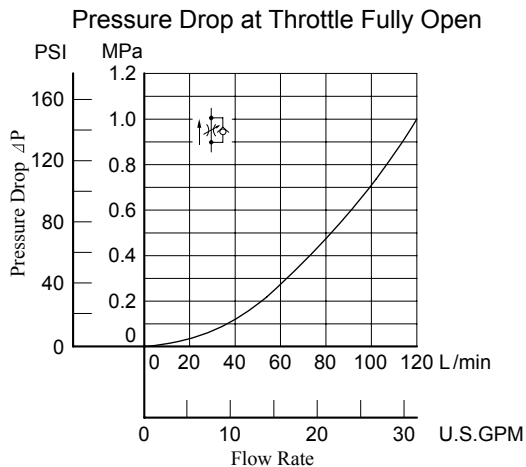
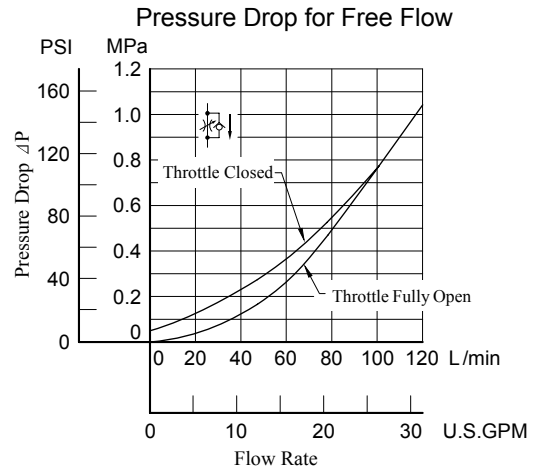
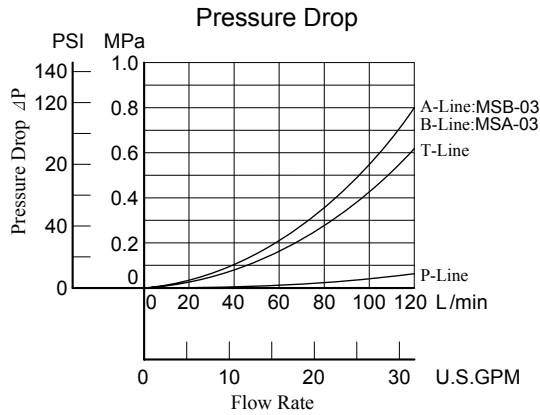

MSW-03-X-40/4090

DIMENSIONS IN
MILLIMETRES (INCHES)

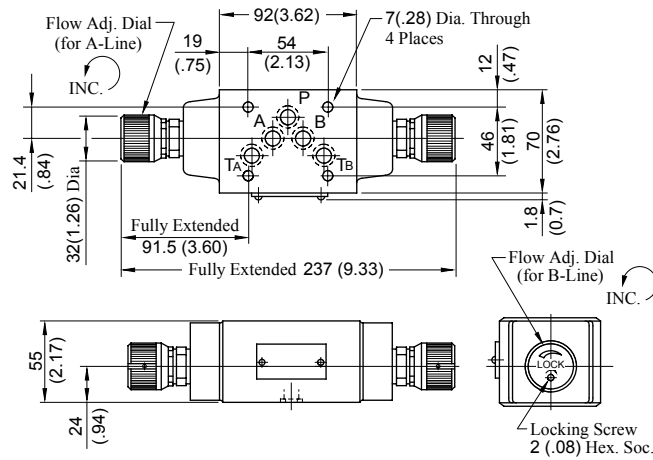

Approx. Mass..... 3.7 kg (8.2 lbs.)

MSA-03-X-40/4090

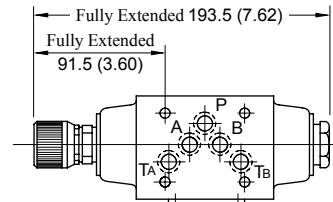

Approx. Mass..... 3.5 kg (7.7 lbs.)

• For other dimensions, refer to "MSW-03" drawing left.

MSB-03-X-40/4090

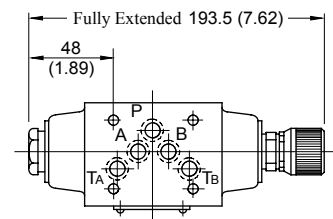

Approx. Mass..... 3.5 kg (7.7 lbs.)

• For other dimensions, refer to "MSW-03" drawing left.

■ Spare Parts List

MSA-03-X-40/4090

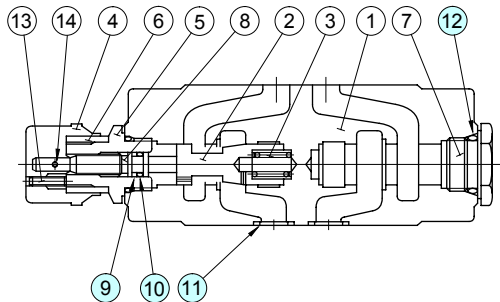

MSB-03-X-40/4090

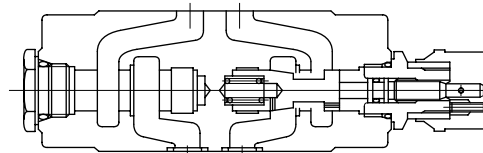

MSW-03-X-40/4090

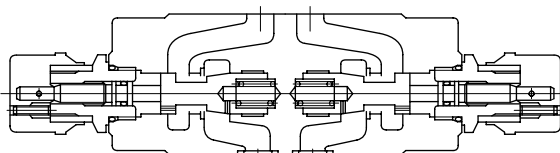

⚠ CAUTION

When making replacement of seals, please do it carefully after reading through the relevant instructions in the Operator's Manual.

● List of Seals

Item	Name of Parts	Part Numbers	Quantity		
			MSA-03	MSB-03	MSW-03
9	Back Up Ring	SO-BB-P8	1	1	1
10	O-Ring	SO-NA-P8	1	1	1
11	O-Ring	SO-NB-A014	5	5	5
12	O-Ring	SO-NB-P18	2	2	2

Note: When ordering seals, please specify the seal kit number from the table right.

● List of Seal Kits

Model Numbers	Seal Kit Numbers
MSA-03	KS-MSA-03-40
MSB-03	
MSW-03	KS-MSW-03-40



3/8, Check Valves

For "P" Line: MCP-03-* -10/1090
 For "A" Line: MCA-03-* -20/2090
 For "B" Line: MCB-03-* -20/2090
 For "T" Line: MCT-03-* -10/1090

MODULAR VALVES

Specifications / Others

Specifications

Model Numbers	Max. Operating Pressure MPa (PSI)	Max. Flow L/min (U.S.GPM)
MCP-03-* -10/1090 MCA-03-* -20/2090 MCB-03-* -20/2090 MCT-03-* -10/1090	25 (3630)	70 (18.5)

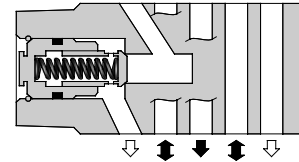

Model Number Designation

F-	MCP	-03	-0	-10	*
Special Seals	Series Number	Valve Size	Cracking Pressure MPa(PSI)	Design Number	Design Standard
F: Special Seals for Phosphate Ester Type Fluids (Omit if not required)	MCP: Check Valve for P-Line	03	0: 0.035(5) 2: 0.2(29)	10	Refer to ★
	MCA: Check Valve for A-Line			20	
	MCB: Check Valve for B-Line			10	
	MCT: Check Valve for T-Line				

★ Design Standards: None Japanese Standard "JIS" and European Design Standard
 90 N. American Design Standard

Typical Performance Characteristics

Hydraulic Fluid: Viscosity 35 mm²/s (164 SSU), Specific Gravity 0.850

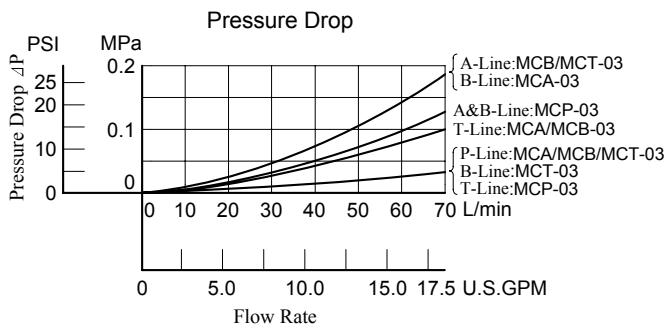
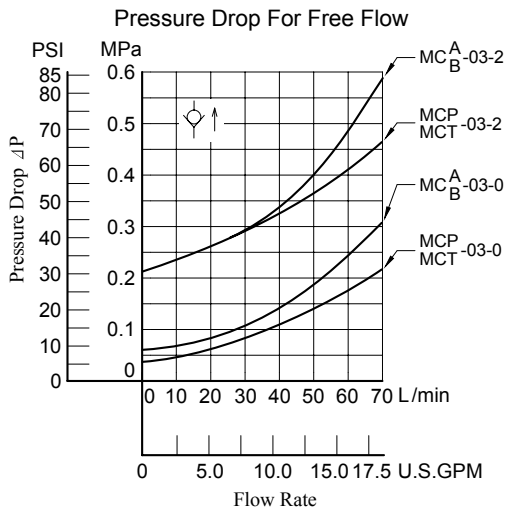

Model No.	Graphic Symbols	Detailed Graphic Symbols
MCB-03		
MCA-03		
MCB-03		
MCT-03		

Instructions

● Tank Line Used

Check valve function of MCT-03 is included in T_A-Line. Therefore, the tank line for a circuit that uses this valve must be T_A-line.

MCP-03-* -10/1090

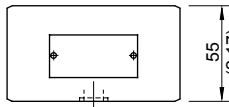
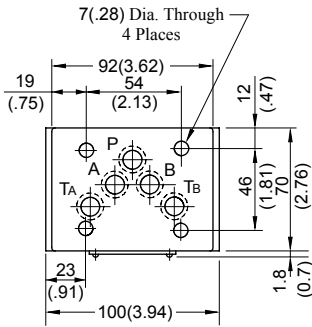

Approx. Mass.....2.5 kg (5.5 lbs.)

MCA-03-* -20/2090 MCB-03-* -20/2090

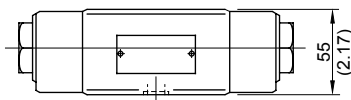
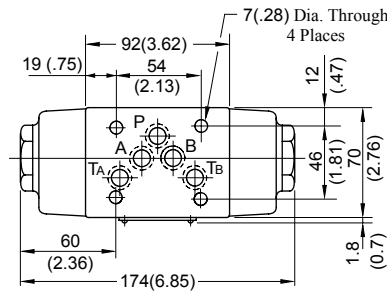

Approx. Mass.....3.5 kg (7.7 lbs.)

MCT-03-* -10/1090

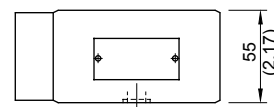
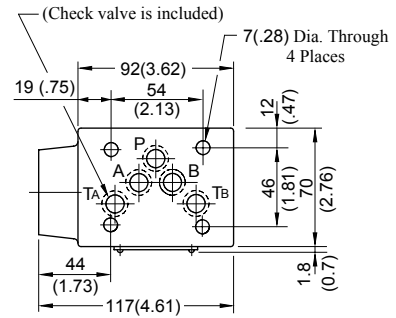

Approx. Mass.....2.8 kg (6.2 lbs.)

DIMENSIONS IN
MILLIMETRES (INCHES)



■ Spare Parts List

⚠ CAUTION

When making replacement of seals, please do it carefully after reading through the relevant instructions in the Operator's Manual.

MCP-03-* -10/1090

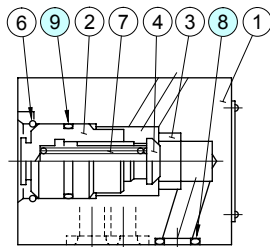

● List of Seals

Item	Name of Parts	Part Numbers	Qty.	Remarks
8	O-Ring	SO-NB-A014	5	Included in Seal Kit Kit No.: KS-MCP-03-10
9	O-Ring	SO-NB-P24	1	

MCT-03-* -10/1090

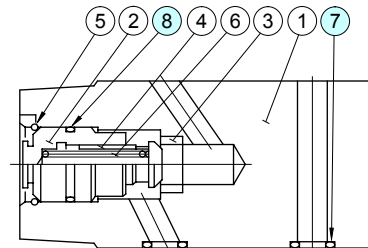

● List of Seals

Item	Name of Parts	Part Numbers	Qty.	Remarks
7	O-Ring	SO-NB-A014	5	Included in Seal Kit Kit No.: KS-MCP-03-10
8	O-Ring	SO-NB-P21	1	

MCA-03-* -20/2090

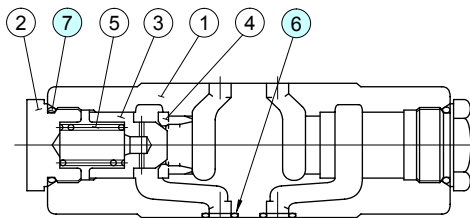

● List of Seals

Item	Name of Parts	Part Numbers	Qty.	Remarks
6	O-Ring	SO-NB-A014	5	Included in Seal Kit Kit No.: KS-MCA-03-20
7	O-Ring	SO-NB-P24	2	

MCB-03-* -20/2090

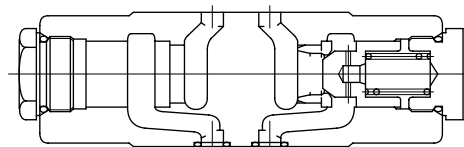

Specifications

Model Numbers	Max. Operating Pressure MPa (PSI)	Max. Flow L/min (U.S.GPM)
MCPT-03-P*-T*-10/1090	25 (3630)	70 (18.5)

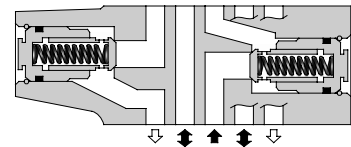

Model Number Designation

F-	MCPT	-03	-P0	-T0	-10	*
Special Seals	Series Number	Valve Size	Cracking Pres. of P-Line MPa(PSI)	Cracking Pres. of T-Line MPa(PSI)	Design Number	Design Standard
F : Special Seals for Phosphate Ester Type Fluids (Omit if not required)	MCPT : Check Valve for P&T-Lines	03	P0 : 0.035(5) P2 : 0.2(29)	T0 : 0.035(5) T2 : 0.2(29)	10	Refer to ★

★ Design Standards: None Japanese Standard "JIS" and European Design Standard
90 N. American Design Standard

Typical Performance Characteristics

Hydraulic Fluid: Viscosity 35 mm²/s (164 SSU), Specific Gravity 0.850

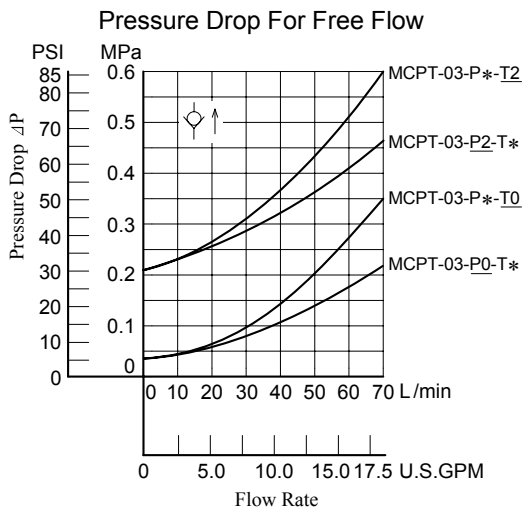

Graphic Symbol

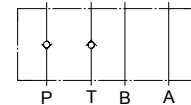

Detailed Graphic Symbol

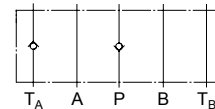

Instructions

● Tank Line Used

Check valve function of Tank Line is included in T_A-Line. Therefore, the tank line for a circuit that uses this valve must be T_A-line.

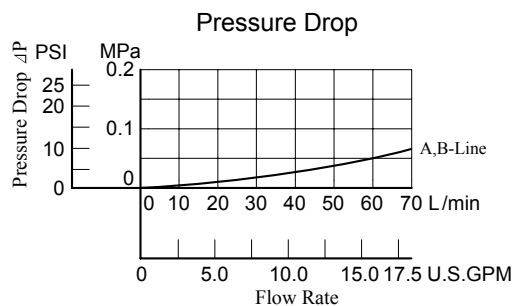

MCPT-03-P*-T*-10/1090

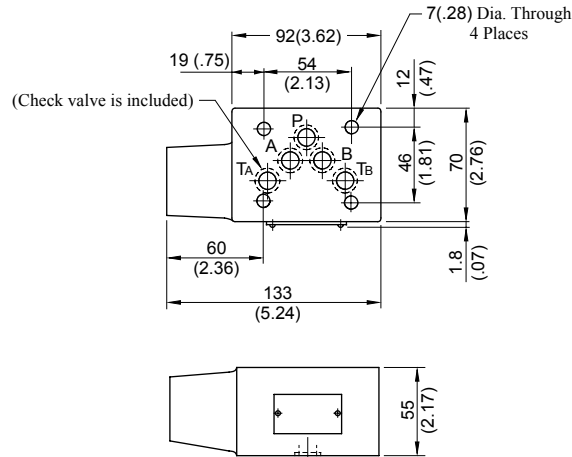

Approx. Mass.....2.7 kg (6.0 lbs.)

**DIMENSIONS IN
MILLIMETRES (INCHES)**



■ Spare Parts List

MCPT-03-P*-T*-10/1090

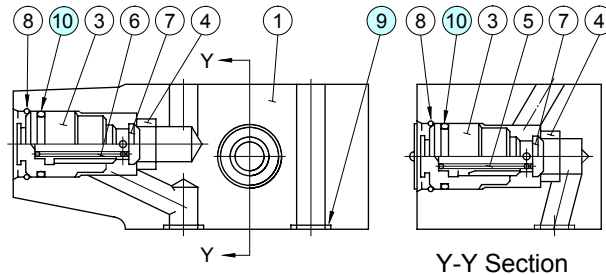

● List of Seals

Item	Name of Parts	Part Numbers	Qty.	Remarks
9	O-Ring	SO-NB-A014	5	Included in Seal Kit
10	O-Ring	SO-NB-P21	2	Kit No.: KS-MCPT-03-10

CAUTION

When making replacement of seals, please do it carefully after reading through the relevant instructions in the Operator's Manual.

Specifications

Model Numbers	Max. Operating Pressure MPa (PSI)	Max. Flow L/min (U.S.GPM)
MAC-03-10/1090	25 (3630)	70 (18.5)



Model Number Designation

F-	MAC	-03	-10	*
Special Seals	Series Number	Valve Size	Design Number	Design Standard
F: Special Seals for Phosphate Ester Type Fluids (Omit if not required)	MAC: Anti-Cavitation Valve	03	10	Refer to ★

★ Design Standards: None Japanese Standard "JIS" and European Design Standard
90 N. American Design Standard

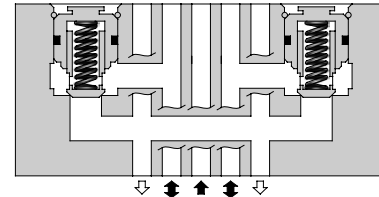

Pressure Drop

Hydraulic Fluid: Viscosity 35 mm²/s (164 SSU), Specific Gravity 0.850

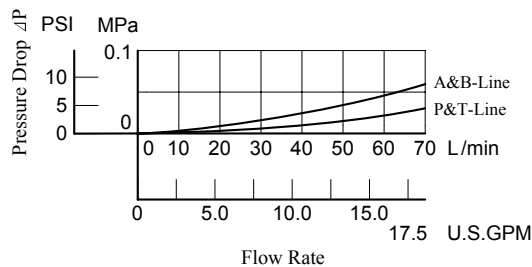

Graphic Symbol

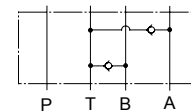

Detailed Graphic Symbol

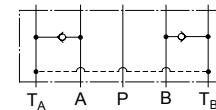

MAC-03-10/1090

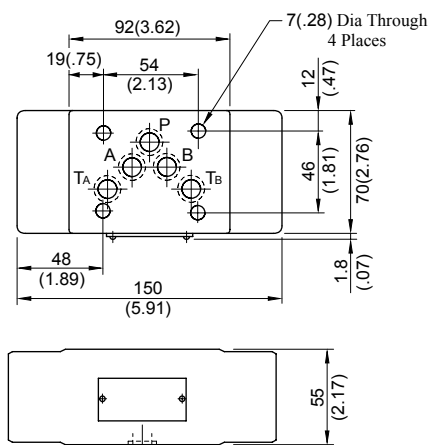

Approx. Mass..... 3.8 kg (8.4 lbs.)

**DIMENSIONS IN
MILLIMETRES (INCHES)**

Spare Parts List

MAC-03-10/1090

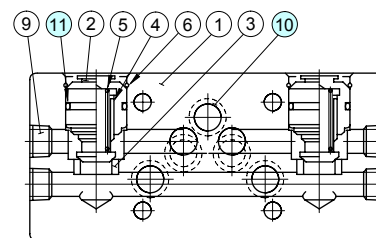

List of Seals

Item	Name of Parts	Part Numbers	Qty.	Remarks
10	O-Ring	SO-NB-A014	5	Included in Seal Kit
11	O-Ring	SO-NB-P21	2	Kit No.: KS-MAC-03-10

⚠ CAUTION

When making replacement of seals, please do it carefully after reading through the relevant instructions in the Operator's Manual.

Specifications / Model Number Designation

■ Specifications

Model Numbers	Max. Operating Pressure MPa (PSI)	Max. Flow L/min (U.S.GPM)
MPA-03-* -20/2090 MPB-03-* -20/2090 MPW-03-* -20/2090	25 (3630)	70 (18.5)



■ Model Number Designation

F-	MPA	-03	-2	-20	*
Special Seals	Series Number	Valve Size	Cracking Pressure MPa (PSI)	Design Number	Design Standard
F: Special Seals for Phosphate Ester Type Fluids (Omit if not required)	MPA: Pilot Operated Check Valve for A-Line MPB: Pilot Operated Check Valve for B-Line MPW: Pilot Operated Check Valve for A&B-Lines	03	2: 0.2 (29) 4: 0.4 (58)	20	Refer to ★

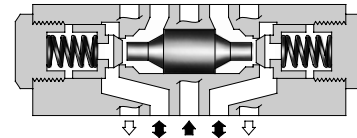

★ Design Standards: None Japanese Standard "JIS" and European Design Standard
 90 N. American Design Standard



Model No.	Graphic Symbols	Detailed Graphic Symbols
MPA-03		
MPB-03		
MPW-03		

Hydraulic Fluid: Viscosity 35 mm²/s (164 SSU), Specific Gravity 0.850

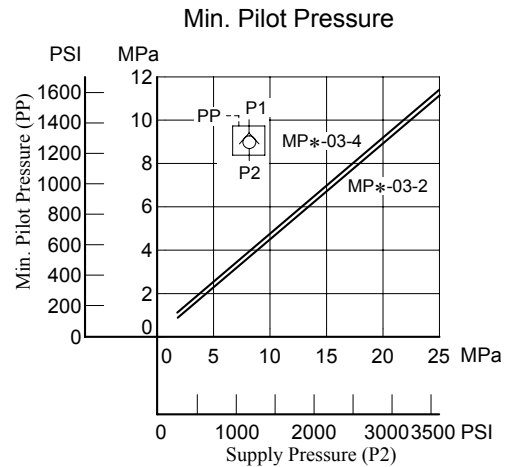
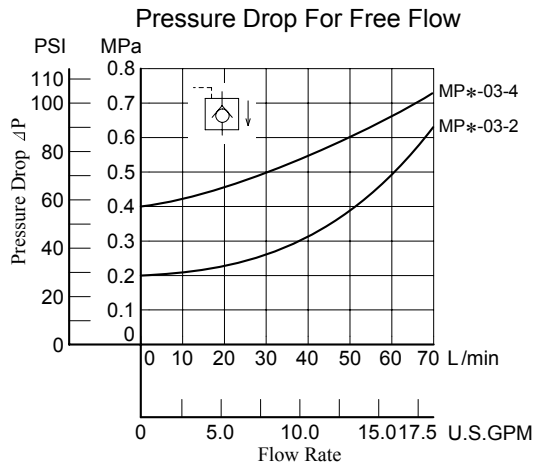
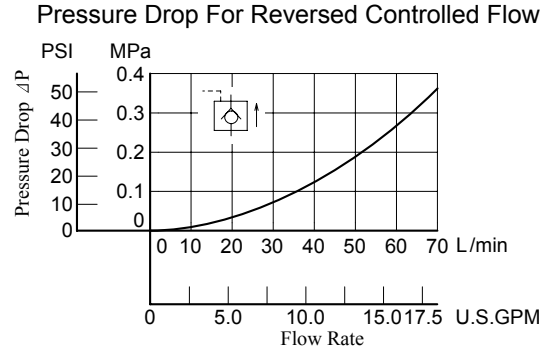
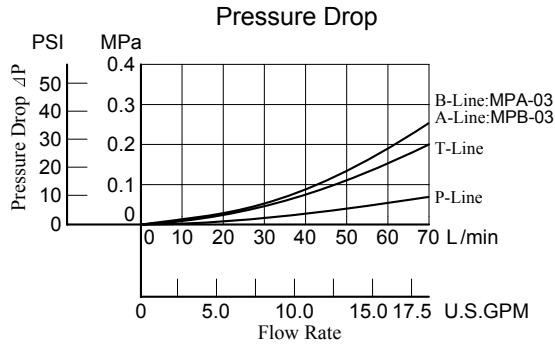

MPA-03-* -20/2090
MPB-03-* -20/2090
MPW-03-* -20/2090

DIMENSIONS IN
MILLIMETRES (INCHES)

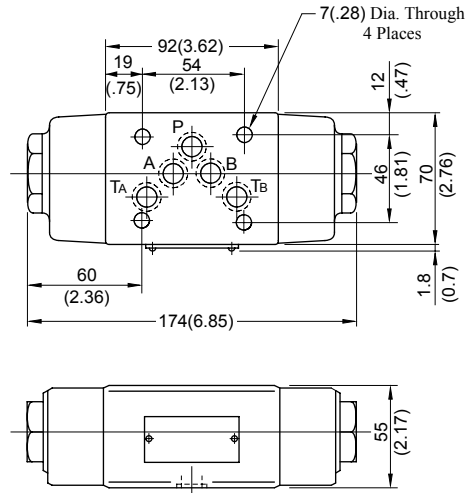

Approx. Mass.....3.5 kg (7.7 lbs.)



■ Spare Parts List

MPA-03-* -20/2090

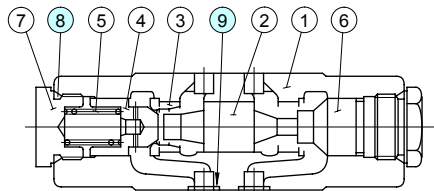

MPB-03-* -20/2090

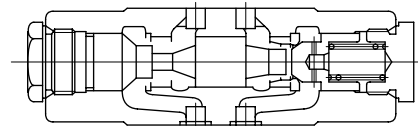

MPW-03-* -20/2090

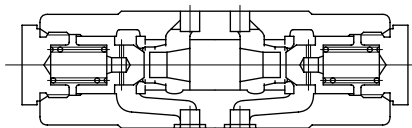

● List of Seals

Item	Name of Parts	Part Numbers	Qty.	Remarks
8	O-Ring	SO-NB-P24	2	Included in Seal Kit
9	O-Ring	SO-NB-A014	5	Kit No.: KS-MPA-03-20



CAUTION

When making replacement of seals, please do it carefully after reading through the relevant instructions in the Operator's Manual.

Blocking plates are used for auxiliary mounting surfaces or for closing unnecessary circuit.

Bypass plates are used for one-way flow circuit that requires no solenoid operated directional valves.



■ Specifications

Model Numbers	Max. Operating Pressure MPa (PSI)	Max. Flow L/min (U.S.GPM)
MDC-03-* -10/1090	25 (3630)	70 (18.5)

■ Model Number Designation

F-	MDC	-03	-A	-10	*
Special Seals	Series Number	Valve Size	Type of Plate	Design Number	Design Standard
F: Special Seals for Phosphate Ester Type Fluids (Omit if not required)	MDC: End Plate	03	A: Blocking Plate B: Bypass Plate	10	None: Japanese Standard "JIS" and European Design Standard 90: N. American Design Standard

■ Pressure Drop

Hydraulic Fluid: Viscosity 35 mm²/s (164 SSU), Specific Gravity 0.850

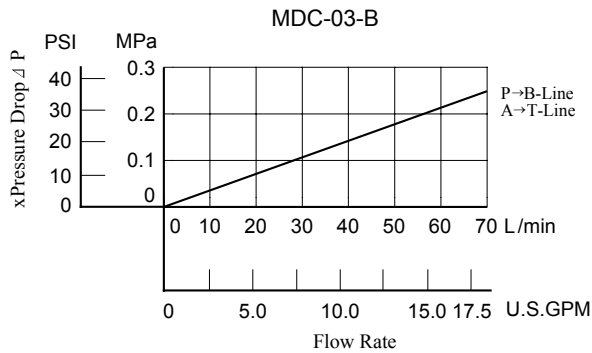

Model No.	Graphic Symbols	Detailed Graphic Symbols
MDC-03-A		
MDC-03-B		

MDC-03-* -10/1090

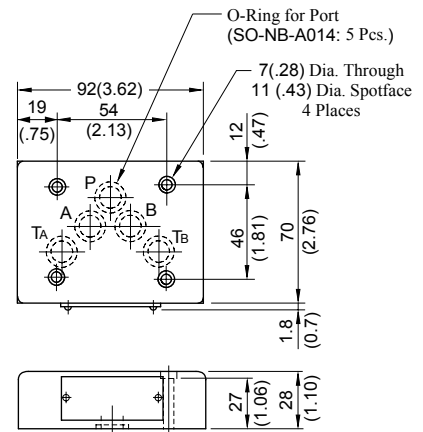

Approx. Mass : 1.2 kg (2.6 lbs.)

DIMENSIONS IN
MILLIMETRES (INCHES)

Specifications

Model Numbers	Max. Operating Pressure MPa (PSI)	Max. Flow L/min (U.S.GPM)
MDS-03-10/1090	25 (3630)	70 (18.5)



Model Number Designation

F-	MDS	-03	-10	*
Special Seals	Series Number	Valve Size	Design Number	Design Standard
F : Special Seals for Phosphate Ester Type Fluids (Omit if not required)	MDS : Connecting Plate	03	10	None : Japanese Standard "JIS" and European design Standard 90 : N.American Design Standard

Pressure Drop

Hydraulic Fluid: Viscosity 35 mm²/s (164 SSU), Specific Gravity 0.850

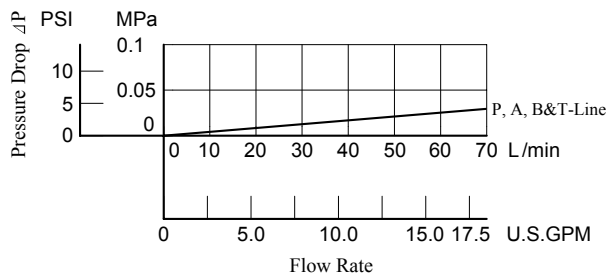

Graphic Symbol

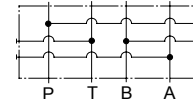

Detailed Graphic Symbol

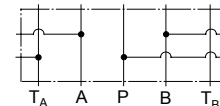

MDS-03-10/1090

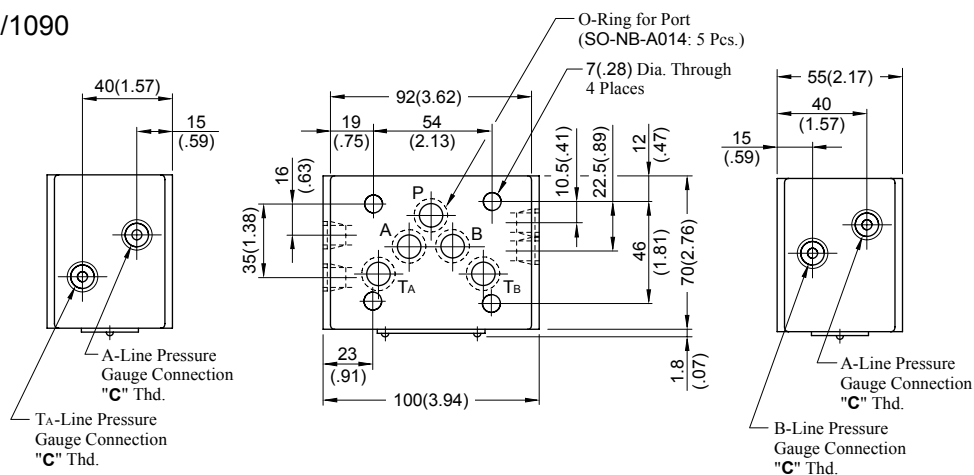

Approx. Mass.....2.5 kg (5.5 lbs.)

Model Numbers	Piping Size "C" Thd.
MDS-03-10	Rc 1/4 = 1/4 BSP.Tr
MDS-03-1090	1/4 NPT

**DIMENSIONS IN
MILLIMETRES (INCHES)**



■ Specifications

Max. Operating Pressure ----- 25 MPa (3630 PSI)



■ Model Number Designation

MMC	-03	-T	-6	-21	*
Series Number	Plate Size	Type of Connection	Number of Stations	Design Number	Design Standard
MMC : Base Plate	03	T : Threaded Connection	1 : 1 Station 2 : 2 Stations 3 : 3 Stations 4 : 4 Stations	5 : 5 Stations 6 : 6 Stations 7 : 7 Stations	21 None : Japanese Standard "JIS" 80 : European Design Standard 90 : N.American Design Standard

■ Pressure Drop

Hydraulic Fluid: Viscosity 35 mm²/s (164 SSU), Specific Gravity 0.850

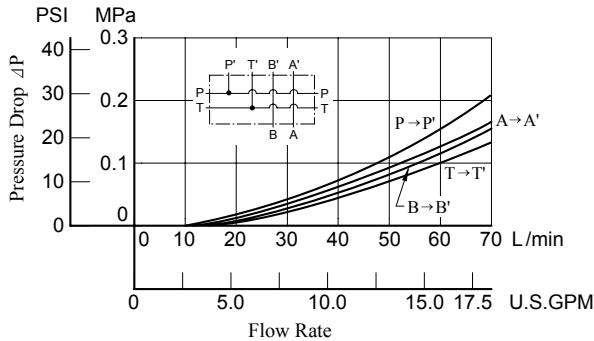

Graphic Symbol

Detailed Graphic Symbol

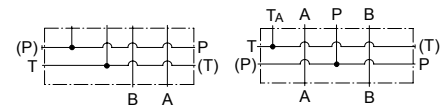

MMC-03-T-1

Graphic Symbol

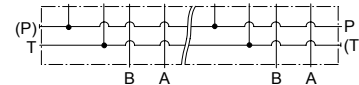

MMC-03-T-2-7

■ Mounting Surface Dimensions for 3/8 Modular Valve

When the standard base plate (MMC-03) is not used, the following mounting surface must be prepared. Also, the mounting surface must have a good machined finish.

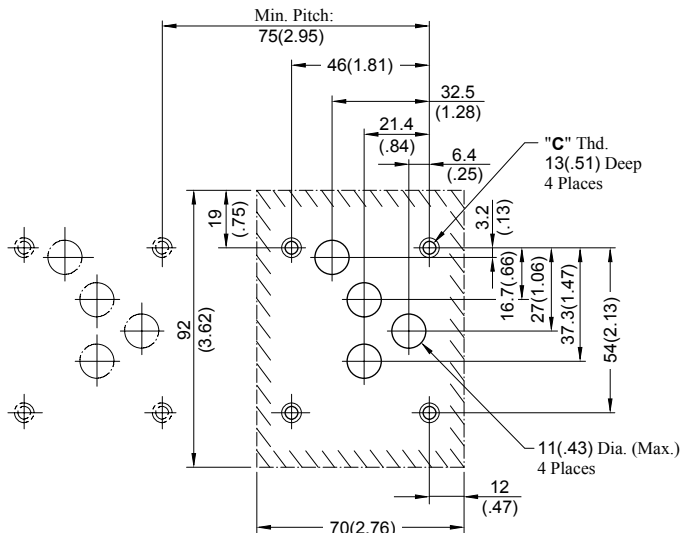

■ Instructions

- Although two ports are provided for both **pressure port "P"** and **tank port "T"**, either may be used.

However, the ports having (P) or (T) in the drawing are normally plugged. Remove the plugs of the ports when they are used. Make sure that the ports that are not currently used are properly plugged.

DIMENSIONS IN
MILLIMETRES (INCHES)

Design Std.	"C" Thd.
Japanese Standard "JIS" and European Design Standard	M6
N.American Design Standard	1/4-20 UNC

MMC-03-T-1-21/2190

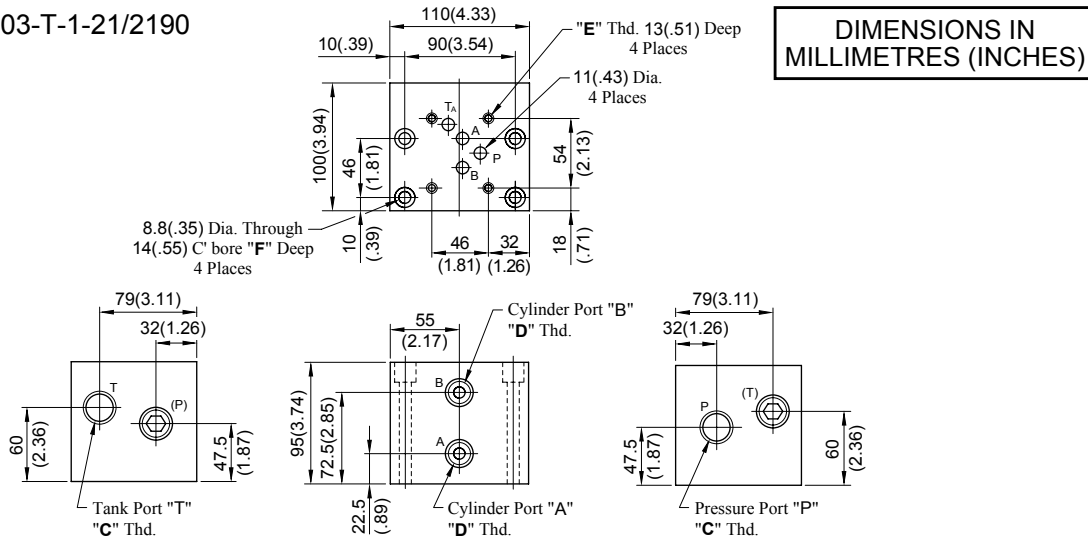

**DIMENSIONS IN
MILLIMETRES (INCHES)**

MMC-03-T-*21/2190

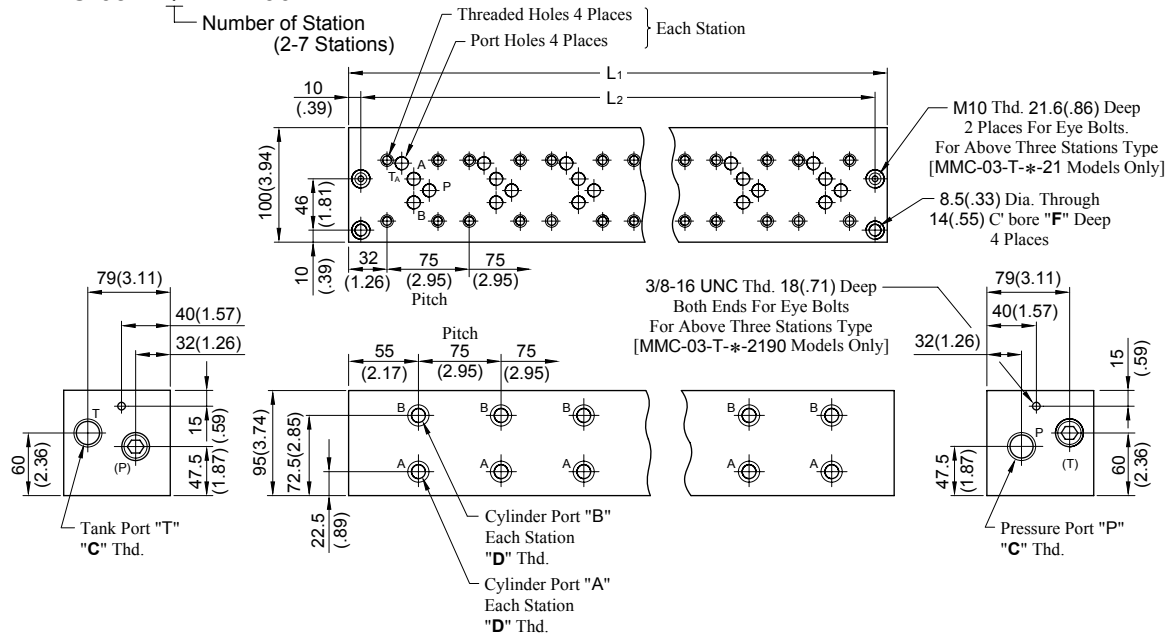

• For other dimensions, refer to above Model MMC-03-T-1.

Model Numbers	Thread Size			Dimensions mm (Inches)			Approx. Mass kg (lbs.)
	"C" Thd.	"D" Thd.	"E" Thd.	F	L ₁	L ₂	
MMC-03-T-1-21	Rc 3/4	Rc 1/2	M6	8.6 (.34)	—	—	8.5 (18.7)
MMC-03-T-1-2190	3/4 NPT	1/2 NPT	1/4-20 UNC	22 (.87)	—	—	—
MMC-03-T-2-21	Rc 3/4	Rc 1/2	M6	8.6 (.34)	185 (7.28)	165 (6.50)	14 (30.8)
MMC-03-T-2-2190	3/4 NPT	1/2 NPT	1/4-20 UNC	22 (.87)	—	—	—
MMC-03-T-3-21	Rc 3/4	Rc 1/2	M6	8.6 (.34)	260 (10.24)	240 (9.45)	19.5 (43.0)
MMC-03-T-3-2190	3/4 NPT	1/2 NPT	1/4-20 UNC	22 (.87)	—	—	—
MMC-03-T-4-21	Rc 3/4	Rc 1/2	M6	8.6 (.34)	335 (13.19)	315 (12.40)	25 (55.1)
MMC-03-T-4-2190	3/4 NPT	1/2 NPT	1/4-20 UNC	22 (.87)	—	—	—
MMC-03-T-5-21	Rc 3/4	Rc 1/2	M6	8.6 (.34)	410 (16.14)	390 (15.35)	30.5 (67.2)
MMC-03-T-5-2190	3/4 NPT	1/2 NPT	1/4-20 UNC	22 (.87)	—	—	—
MMC-03-T-6-21	Rc 3/4	Rc 1/2	M6	8.6 (.34)	485 (19.09)	465 (18.31)	36 (79.3)
MMC-03-T-6-2190	3/4 NPT	1/2 NPT	1/4-20 UNC	22 (.87)	—	—	—
MMC-03-T-7-21	Rc 3/4	Rc 1/2	M6	8.6 (.34)	560 (22.05)	540 (21.26)	41 (90.4)
MMC-03-T-7-2190	3/4 NPT	1/2 NPT	1/4-20 UNC	22 (.87)	—	—	—



MMC-03-T-1-2180

**DIMENSIONS IN
MILLIMETRES (INCHES)**

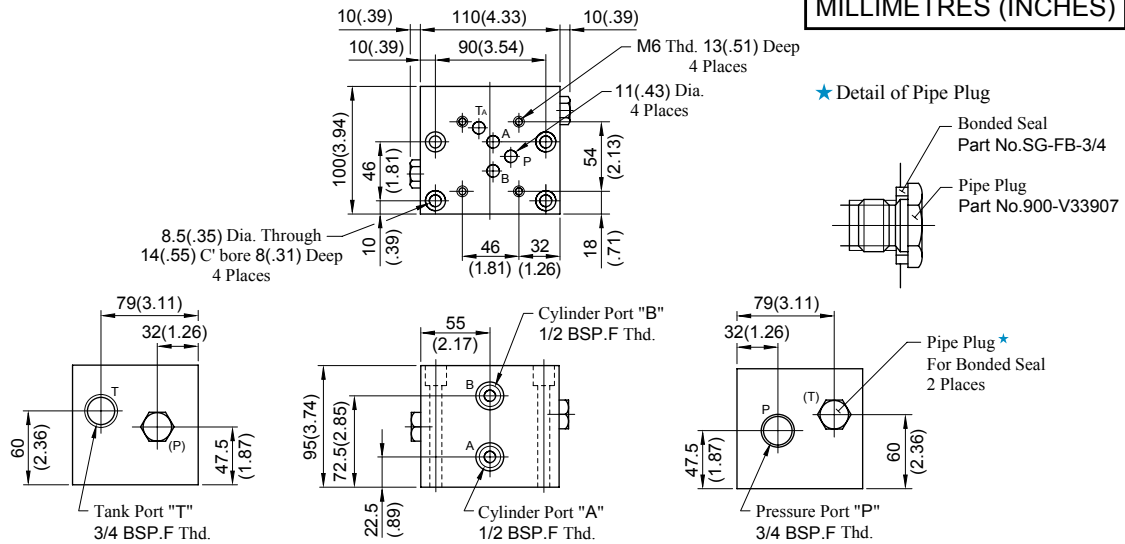

Approx. Mass : 8.5 kg (18.7 lbs.)

MMC-03-T-***-2180

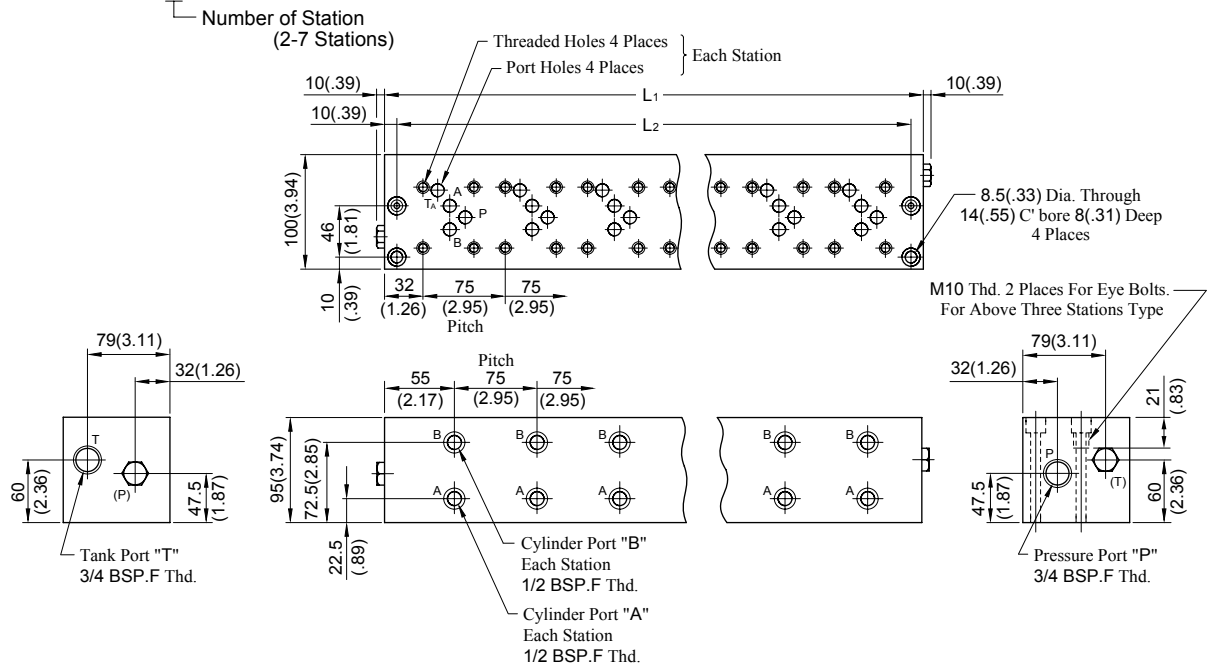

• For other dimensions, refer to above Model MMC-03-T-1.

Model Numbers	Dimensions mm (Inches)		Approx. Mass kg (lbs.)
	L ₁	L ₂	
MMC-03-T-2-2180	185 (7.28)	165 (6.50)	14 (30.8)
MMC-03-T-3-2180	260 (10.24)	240 (9.45)	19.5 (43.0)
MMC-03-T-4-2180	335 (13.19)	315 (12.40)	25 (55.1)
MMC-03-T-5-2180	410 (16.14)	390 (15.35)	30.5 (67.2)
MMC-03-T-6-2180	485 (19.09)	465 (18.31)	36 (79.3)
MMC-03-T-7-2180	560 (22.05)	540 (21.26)	41 (90.4)

Valves are mounted with four stud bolts. Valve combination varies according to the circuit type. Hence, the mounting bolt kits are available on a combination type basis.

When ordering the mounting bolt kit, be sure to give the bolt kit model number from the table below.

Model Number Designation

MBK	-03	-04	-10	*
Series Number	Size of Modular Valve	Bolt Number	Design Number	Design Standard
MBK: Mounting Bolt Kits for Modular Valve	03	01, 02, 03, 04, 05 (Refer to the following chart)	10	Refer to ★

★ Design Standards: None Japanese Standard "JIS" and European Design Standard 90 N. American Design Standard



Bolt Kit Composition

Stud Bolt----- 4 Pcs. } 1 Set
Nut----- 4 Pcs. }

Note: In case of bolt kit model number having "05", 4 hexagon socket head cap screws only.

Tightening Torque:

12-15 Nm (106-133 IN. lbs.)

Bolt Kits Selection Chart

Model Numbers	Quantity of valves to be stacked			Approx. Mass g (lbs.)
	Solenoid Operated Directional Valve (*-DSG-03)	End Plate (MDC-03)	Modular Valve & Connecting Plate	
MBK-03-01-10*	1	0	1	120(.26)
	0	1		
MBK-03-02-10*	1	0	2	160(.35)
	0	1		
MBK-03-03-10*	1	0	3	200(.44)
	0	1		
MBK-03-04-10*	1	0	4	240(.53)
	0	1		
MBK-03-05-10*	1★	0	0	40(.09)
	0	1		

★ The solenoid operated directional valve comes with mounting bolts.

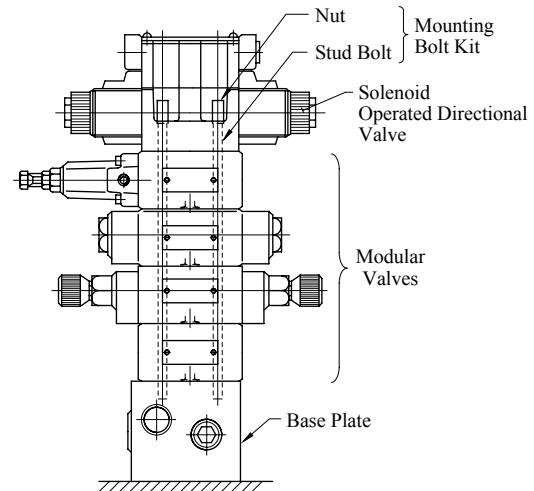

03 Series Modular Valve Assembly

MBK-03-*-10/1090

Stud Bolt

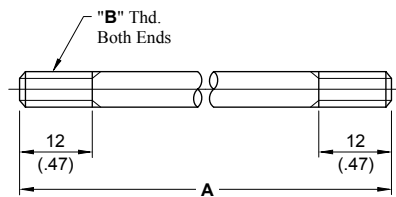

Nut

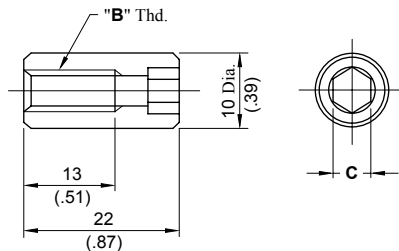

MBK-03-05-10/1090

Socket Head Cap Screw

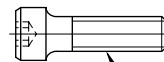

MBK-03-05-30: M6×35 Lg.
MBK-03-05-3090: 1/4-20 UNC x1-1/2 Lg.

DIMENSIONS IN
MILLIMETRES (INCHES)

Model Numbers	A mm (In.)	"B" Thd.	C
MBK-03-01-10	103 (4.06)	M6	5 (.20)
MBK-03-02-10	158 (6.22)		
MBK-03-03-10	213 (8.39)		
MBK-03-04-10	268 (10.55)		
MBK-03-01-1090	103 (4.06)	1/4-20 UNC	4.76 (3/16)
MBK-03-02-1090	158 (6.22)		
MBK-03-03-1090	213 (8.39)		
MBK-03-04-1090	268 (10.55)		